

SWITCH

to inclusive design **2.0**

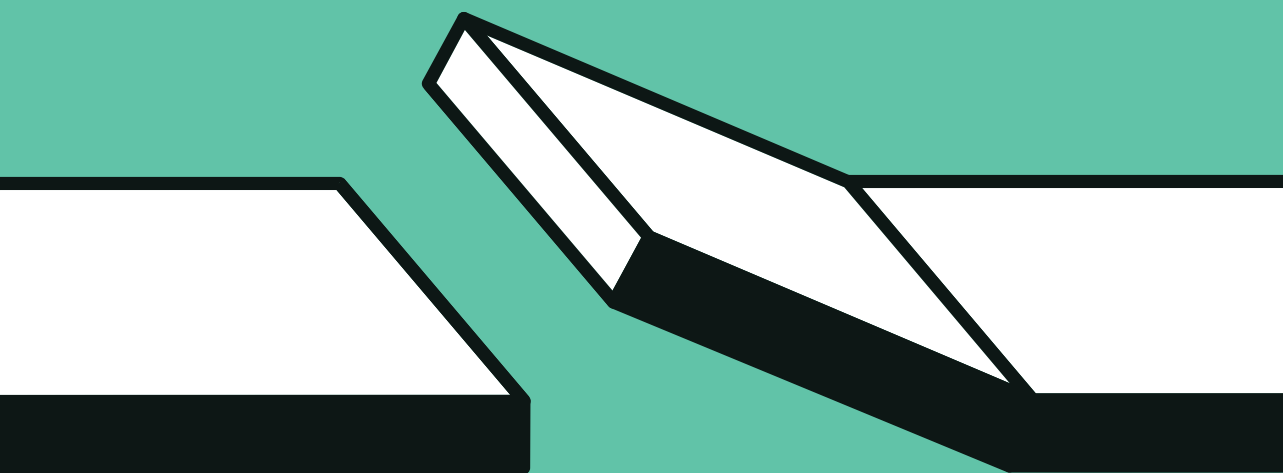

Kamil Kowalski

SWITCH 2.0

This publication was created thanks to:



Integracja Foundation

SKANSKA

Skanska Property Poland

Skanska Residential Development Poland (1st edition)

Partners of 2nd edition:

BURO HAPPOLD

Buro Happold Polska Sp. z o.o.



ISS World Services A/S

Author / Kamil Kowalski

Project Team / Jarosław Bogucki, Anna Drzewiecka, Skanska,
(1st edition: Jarosław Bogucki, Joanna Ejsmont, Monika Okrasa, Tomasz Pisarzewski)

Editor and Revision / Iwona Kuc

Graphic design / Tomek Domański i Mikołaj Olizar-Zakrzewski – Takie.Pany

Typesetting / Leszek Dubel, Łukasz Piotrowski (1st edition: Barbara Sadowska, Marta Burda, Tomek Domański)

Translation / Katarzyna Oraczewska

Warsaw 2024

ISBN 978-83-951357-7-4

© Copyright by Fundacja Integracja

All rights reserved.

Publication free of charge. Electronic version available for download at www.integracja.org/wlacznik

SWITCH 2.0

to inclusive design

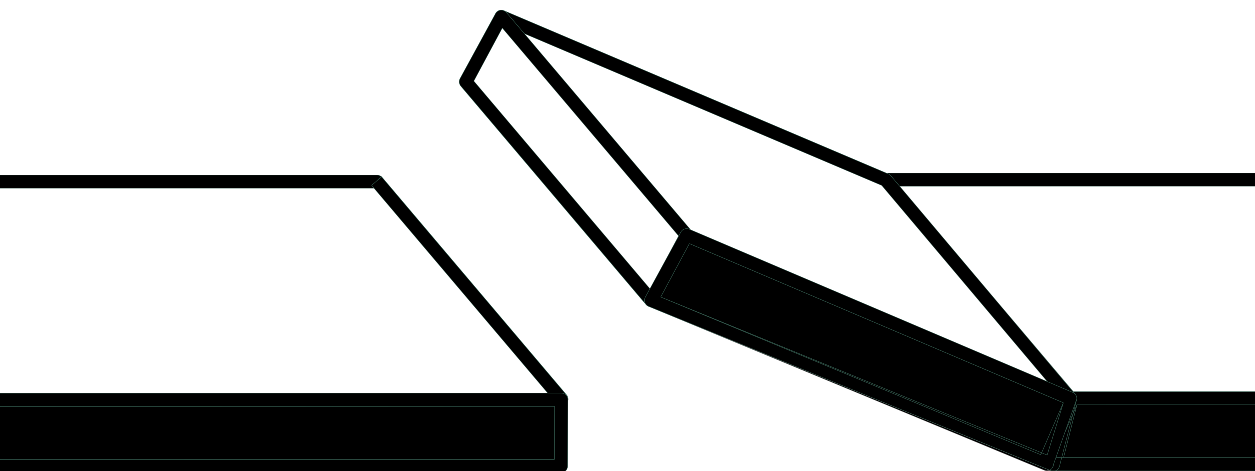

INTRODUCTION

Acknowledgements

We are handing over to you the new edition of THE SWITCH. I say ‚we’ because it is the work of many people. For this reason, I would like to start by acknowledging them.

At the beginning, words of gratitude go to Piotr Pawlowski. The SWITCH would not have come into being if it had not been for one moment – the decision to jump in headfirst. Without that, there would be no Integracja and the path of many people whom Piotr Pawłowski inspired to enter the world of accessibility would have been different. I was one of those people. Back then, just out of university, with a desire to put the world back together and a conviction that I knew everything better. Today, after writing the last sentence for the new edition of SWITCH, I realise how much work is still ahead of me and I am already thinking about the next edition.

To Ewa Pawłowska for continuing the mission of Integracja after the death of Piotr Pawłowski. I know how difficult this task is. Her way of leading such a large and important organisation is inspiring.

To Skanska, without whom it would not have been possible to create and put into your hands both editions of the SWITCH.

To the team working on both editions (in alphabetical order): Jarek Bogucki, Joanna Ejsmont who never gave us a break, Monika Okrasa, Tomek Piszczewski. To TAKIE PANY for their excellent understanding of the subject, illustrating it and, finally, to the entire editorial team.

Now a little more private. To Gosia, Laura and Marysia for changing the way I look at the world, because you are the whole world.

To all those who have left their mark on my path: my parents, who gave it direction, Piotr Pereplyś, who forced me to make even greater efforts during my studies, Czesława Frejlich, with whom I had the honour of working at the Faculty of Design of the Academy of Fine Arts in Warsaw, and who has had a great influence on my way of thinking about design and a human being, or rather a human being and design.

Finally, to all those who contributed their comments to the first edition of the SWITCH: Piotr Czarnota, Janek Cieśła, Dorota Sibińska, Adam Wach, Pressalit, and the LAB team, without whose support nothing could have been done: Aneta Dąbrowska-Kodym, Anna Drzewiecka, Katarzyna Rzehak – I have mentioned Jarek before.

I would also like to thank everyone, whom I have not mentioned by name, who has contributed at least in the smallest way to this valuable publication. Everyone, who has inspired, mobilised and shaken me out of my sense of balance. SWITCH 2.0 is our shared creation!

About the publication

In the introduction to the first edition, I wrote about how much has changed in 15 years and how much more needs to be done. At the time I pointed out that it was not just about taking into account the needs of wheelchair users, but also blind and partially sighted people, deaf and hard of hearing people, old and young people, parents with children and many others. The provision stating that accessibility is mainly about wheelchair users has since disappeared from the Polish Building Act. Instead, the Act on Ensuring Accessibility for Persons with Special Needs has been introduced, and we are awaiting the entry into force of the amendments to the Regulation on Technical Conditions to which Buildings and their Situations should conform and the European Accessibility Act. We are talking about diversity and neurodiversity. I believe that the answer to these issues is good architecture. That is why in SWITCH we write not only about parameters, but also about the material solutions, lighting, information and acoustics that, when well designed, make us feel better in a building.

We continue to feel that the best basis for good designs is universal design and its principles:

- **Equitable use** – the solution should be both useful and appealing to people of different physical abilities.
- **Flexibility in use** – the solution should take into account the needs and capabilities of various types of users. Examples: a table with adjustable table top height; taking into account right- and left-handed operation.
- **Simple and intuitive** – the use of the solution should be easy to understand and independent of the user's experience, knowledge, language skills or degree of concentration. Examples: simple, pictorial user manuals; intuitive menus for electronic devices.
- **Perceptible information** – Information should be legible regardless of the environment and the sensory capabilities of users. Examples: colour distinctions or giving symbols to individual building zones; simultaneous visual and auditory or tactile information.
- **Tolerance for error** – The solution should minimise the danger and negative consequences of accidental or unintended user actions. Example: the possibility of undoing recent actions in an application.
- **Low physical effort** – using the solution should be possible in an efficient, comfortable and non-fatiguing way for the user. Examples: large, high-contrast markings that do not require the user to focus their eyes; buttons and panels at a height that does not require the user to stretch their arms too far; doors that open automatically.
- **Size and space for approach and use** – the space and parameters of the solution should be such that it can be used regardless of the body parameters,

posture, mobility of the user and the equipment they use. Examples: provision of wider access control gates for wheelchair users; in urban transport provision of low-floor vehicles with seats for people with disabilities¹.

In SWITCH, you will find information on how to design to be in line with these principles. Does accessibility mean meeting all the parameters described in this publication? Definitely not. It is about applying them wisely. Always aiming to meet the needs and respond to the capabilities of the people who will use the architecture. At the same time, just meeting them all, without being aware of the goal, will not produce good results. Is it possible to do things differently? When writing the SWITCH, to simplify the message, we referred primarily to Polish regulations, ISO 21542:2021 and ADA. Standards for Accessible Design. These are definitely not all the norms and standards that talk about universal design and accessibility. We also encourage you to use other reliable sources, compare and draw your own conclusions.

We have done our best to make this publication the best it can be. However, we would be grateful for any suggestions on how we can further improve the SWITCH. See you in the next edition.

What has changed

More than seven years after the first edition, the SWITCH required changes due to revised regulations, new editions of standards, changing technical solutions, as well as new knowledge and experience that we had gained.

Here are the most important of these changes:

- In the entire publication:
 - inclusion of amendments to Article 5 of the *Construction Law Act*,
 - reference to the law passed in 2019 on ensuring accessibility for persons with special needs,
 - changes to the parameters of pavements resulting from the new regulation on technical and construction regulations for public roads,
 - incorporation of changes in the new version of ISO 21542:2021
 - incorporation of changes in the new version of ISO 23599:2019,
 - addition of information on new technical developments,
 - clarification and supplementation of some information,
 - update of drawings,
 - editorial corrections,
 - supplementation of the bibliography.

¹ The principles of universal design, NC State University, The Center for Universal Design, 1997.

- Chapter A:
 - treating disability as one of the factors that influences diversity,
 - elaboration on the principles of using anthropometric data,
 - refinement of anthropometric data (providing data for the 5th and 95th percentile instead of data for the 50th percentile in the first edition).
- Chapter B.5:
 - addition of information on alternative ways to make the door stand out against the wall,
 - modification of patterns and minimum parameters of contrast calculated using LRV.
- Chapter B.6:
 - with regard to lighting, the addition of information on the colour rendering index (Ra).
- Chapter B.7:
 - addition of further principles to the design of visual information, including attention to more factors affecting the legibility of fonts, symbols and all information and how they affect each other,
 - revision of the information on the rules for calculating the size of characters in visual information,
 - structuring the rules on tactile information,
 - addition of information on NFC tags,
 - zchanges to the types and parameters of tactile pathways based on ISO 23599:2019,
 - addition of information on audio tags.
- Chapter 1.2:
 - addition of information on the mandatory use of tactile paths on pavements over 4 m wide which form part of a public road.
- Chapter 2.1:
 - change in width of pavements on public roads due to changes in current legislation.
- Chapter 2.5:
 - supplementary information on the ergonomic parameters of seats.
- Chapter 3.1:
 - addition of information about the possibility of placing parking spaces for people with disabilities without maintaining minimum distances from building windows.
- Chapter 3.2:
 - supplementation of information on the number of off-road parking spaces for people with disabilities.

- Chapter 3.3:
 - removal of information on the possibility of limiting the width of parking spaces for people with disabilities to 230 cm, while maintaining access to the pavement.
- Chapter 6.3:
 - supplementary information on lift control using DCS.
- Chapter 6.5:
 - addition of information on the possibility of purchasing a vertical lift with a closed cabin,
 - addition of new types of lift: retractable in-floor and stairs.
- Chapter 8.4:
 - introduction of changes resulting from changes in the organisation of offices, including the non-attachment of an employee to a specific working place.
- Chapter 8.5:
 - additional information on how to calculate the number of seats for people with disabilities for small meeting rooms – up to 50 people.
- Chapter 10.3:
 - modification of the provisions concerning the determination of the free space around the toilet bowl,
 - removal of the design of the handrail at the toilet bowl based on ADA. Standards for Accessible Design, due to the lack of equipment on the Polish market that allows such solutions to be introduced.
- Chapter 10.6:
 - revision of information on situations where it is necessary to provide a room in the building for a parent with a child,
 - addition of examples of solutions to increase the comfort of the parent using the parent-child room.
- Chapter 10.7:
 - addition of a new chapter on changing places.



AR.

MOZ.

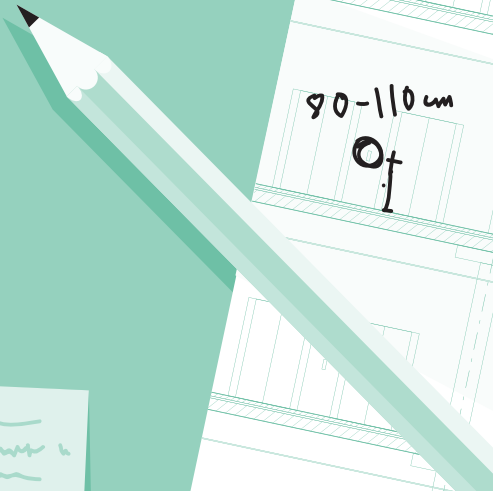

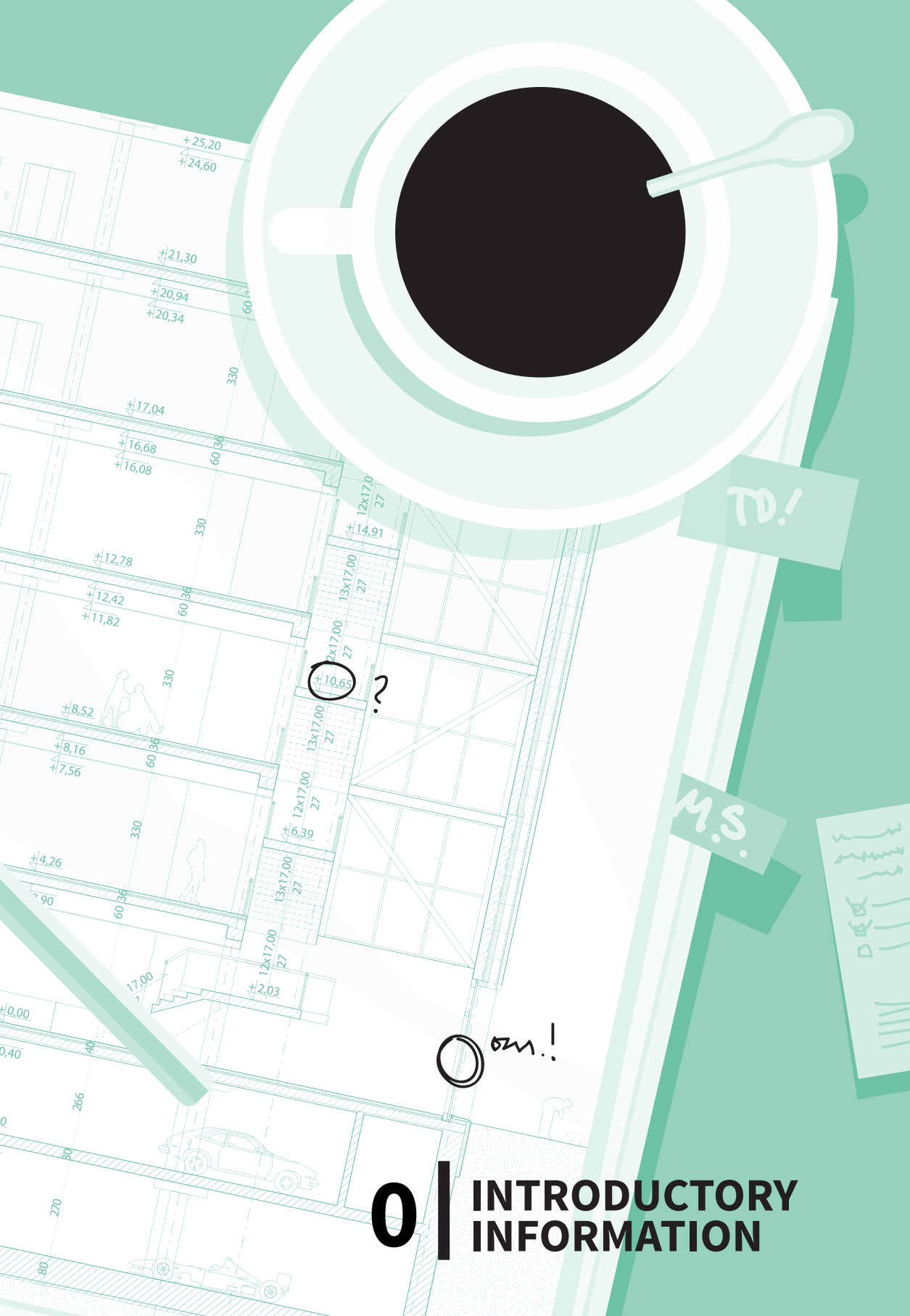

TD!

M.S.

0 | INTRODUCTORY INFORMATION

A

USER PARAMETERS

How we use architecture depends on many factors: how we move, our perception of our surroundings, how we understand them, how we feel them, and even what culture we come from.

No two people in the world are identical. Our bodies are different – different height, arm reach, different fitness and strength. Our senses perceive images, touch, smell and taste differently. Children interpret the world differently from adults and other things are important to them. As the body and brain age, our physical and mental agility decreases. From birth onwards, our senses are slowly weakened – the acuity of our close-up vision decreases, the range of sounds perceived by our ears is reduced.

People cannot be easily divided into able-bodied and disabled. We are simply different. Instead, diversity stems from the differences in many of the characteristics that determine who we are, what we expect and what we are able to do.

We can use the terms **person with special needs** and **person with reduced mobility**. The former refers to anyone who, „because of their external or internal characteristics, or because of the circumstances in which they find themselves, needs to take extra steps or apply extra measures to overcome a barrier in order to participate in various spheres of life on an equal basis with others”.² A person with special needs can be anyone – because of mobility or sensory limitations, age, injury, the situation they are in or their level of concentration.

We only use the second term to refer to people who have limited mobility, e.g. they use a wheelchair, a cane or crutches, have difficulty climbing stairs or walking long distances. These limitations may be due to muscular or skeletal disabilities, neurological or cardiovascular conditions, age, injury and sometimes situations (e.g. a person with a pushchair, heavy luggage).

A.1. Movement and arm reach

We usually get around by walking, but there are some of us who, due to disability, age, cardiovascular disease, injury or past surgery, need aids such as crutches, canes, prostheses, wheelchairs (active and electric).

For some it can be difficult to walk a greater distance, for others to stand up or sit down, open a door or grasp a poorly designed handle. Low people, children and

² Act of 19 July 2019 on ensuring accessibility for persons with special needs, Journal of Laws. 2019 item 1696, art. 2 item 3.



wheelchair users will not reach shelves and buttons that are too high, and people with a bad back or joints may not bend down to objects that are too close to the floor. Well-designed architecture should take this diversity into account.

The parameters of the circulation space will be determined by the people who need the most space. Typically, these will be wheelchair users.

Three main groups of wheelchairs can be distinguished:

- **Active wheelchairs** – are primarily used by people with lower limb disabilities and those with quadriplegia with relatively able upper limbs. This type of wheelchair is usually smaller, fairly manoeuvrable and lightweight.
- **Electrical wheelchairs** – are used most often by people with quadriplegia, as well as those with congenital bone fractures and others for whom it may not be possible to walk long distances. These types of wheelchairs are larger in size, requiring more space to manoeuvre. They are also relatively heavy, so even with the support of others, it will be impossible to climb a few steps.
- **Orthopaedic wheelchairs** – most commonly found in hospitals. They are best suited to being pushed by an assistant and are therefore used to transport elderly and temporarily disabled people. These wheelchairs are not very manoeuvrable and are heavier than active wheelchairs, so they are very rarely used by those who move independently. It is this type of wheelchair that often appears in photographs and is drawn in project documentation.

Performance of different types of wheelchairs. Compiled on the basis of data from wheelchair manufacturers and distributors and ISO 21542:2021

	Active	Electrical	Orthopaedic
			
Wheelchair length	75-90 cm	100-130 cm <i>may be longer in individual situations</i>	up to 130 cm

	Active	Electrical	Orthopaedic
Wheelchair width	50-70 cm	60-70 cm	do 75 cm
	+10 cm – space required by the arms of the person using the wheelchair		
Wheelchair weight	2-20 kg	up to 150 kg <i>together with a person sitting in a wheelchair up to 250 kg</i>	13-25 kg
Space required to turn wheelchair by 90°	120 x 120 cm	150 x 150 cm	140 x 140 cm
Space required to turn wheelchair by 180°	120 x 140 cm	150 x 220 cm	140 x 175 cm

Technological changes, including access to lighter and more advanced batteries, are making modern electric wheelchairs lighter and lighter. Active wheelchair users, on the other hand, are increasingly using electric attachments to improve mobility. Scooters, which require even more space than electric wheelchairs (180° turning radius of up to 210 cm), are also being used more frequently. However, they are mostly used by people for whom walking long distances is a problem and who are able to dismount. The parameters of the space, furniture, installation

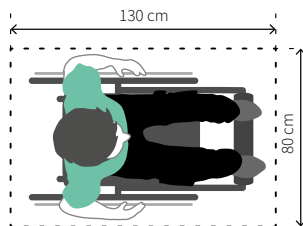

Wheelchair dimensions for determining the minimum parameters for circulation spaces. These parameters do not take into account people who, for example, have to move with their legs extended forward or in a lying position. Authors' compilation based on ISO 21542:2021.

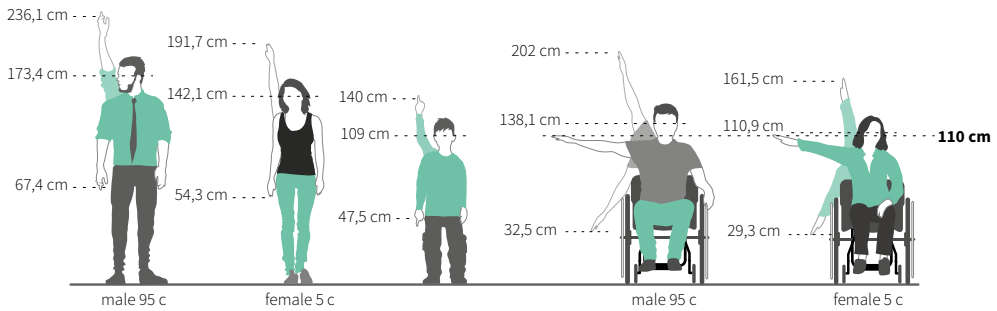

*Comparison of arm ranges of different people. For wheelchair users, the individual parameters can vary significantly depending on the type and severity of the disability. The line of sight can be as much as 20 to 30 cm lower than indicated in the figure. Arm reach, even for a tall person with long arms, may be limited to 110 cm. Compiled from A. Giedliczka, *Atlas of Human Measurements. Data for ergonomic design and assessment*, CIOP, E. Nowak, *Atlas antropometryczny populacji polskiej*, Warsaw 2000; E. Kuryłowicz, *Universal Design, /Stockholm a city for everyone*, Perinilla Johnni, Catarina Thuresson, *Integracja*, Warsaw 2005.*

height of equipment and other features of the architecture can be determined using the so-called limiting measures method. Depending on the situation, different parameters are used:

- Parameters of the largest person or the person using the largest equipment (usually 95th percentile) – whenever we decide on the parameters of the circulation space or need to place something out of reach of all people. The width of the communication space adjusted to the parameters of the electric wheelchair or the height of the door taking into account the tallest person will be comfortable for any smaller user. Placing dangerous items out of reach of the tallest person will ensure that nobody can reach them..
- Smallest person parameters (usually 5th percentile) – whenever we design items that everyone should be able to reach, and also in situations where we want to prevent access to dangerous items. If we place the highest shelves within reach of the lowest person, everyone can reach them. A door that can be opened by the weakest person can be reached by anyone who is stronger than he or she. Holes in the railing to prevent children from squeezing through will keep everyone safe.
- Average person parameters (usually the 50th percentile) – whenever we are designing an item that should be rated as comfortable or acceptable by the greatest number of people, or we want to minimise negative effects on extreme people. A desk top or door handle, placed at a height appropriate for the average person, will be rated as comfortable by the most people and at the same time as acceptable by the lowest and the tallest.

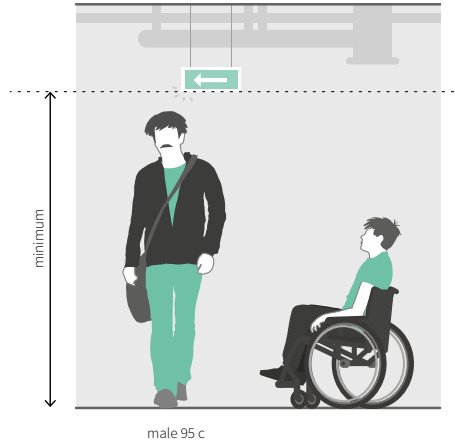

Principle of using the parameters of person 95 pth.

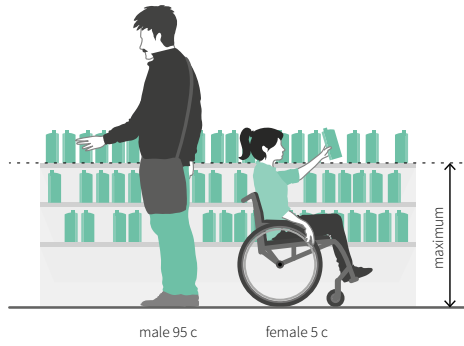

Principle of using the parameters of person 5 pth.

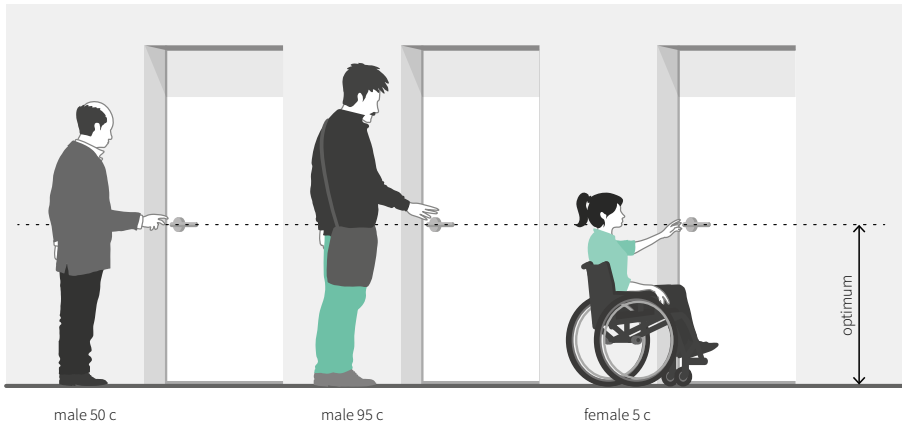

Principle of using the parameters of person 50 pth.

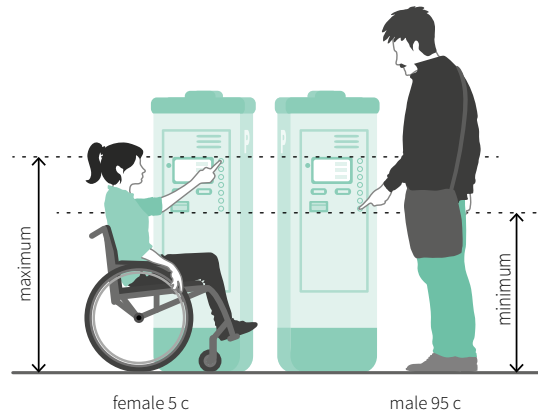

The principle of comparing the parameters of people 5 pth and 95 pth.

- Determining a common range – whenever we need to determine a common space, e.g. to find out at what height to place important controls for light, intercom, air conditioning, vending machine. The upper limit for placing light switches is determined by the upper reach of a person sitting in a wheelchair or a child (ideally measured to shoulder height), while the lower limit is determined by checking the lower reach of the tallest person.

A.2. Perception

We seem to get most of our information through sight. However, all we need to do is a simple experiment – if we try to walk around the city blindfolded, preferably accompanied by someone to keep us safe, we will find that we can easily recognise when someone passes us, when we enter a park or approach a street. We can even determine from the movement of cars that we have just had a red light. We can hear a tram approaching or feel the vibrations and rush of air being forced into an underground tunnel to herald the arrival of the next train. We can tell from the smell of fresh bread that there is a bakery nearby.

Often in design, we underestimate the world of sounds, smells, temperature changes, vibrations and breezes felt by our bodies. This is brilliantly recognised by sales professionals, who deliberately offer us the smell of food, perfume and perfectly timed melodies to boost their sales figures.

When visual, auditory, olfactory or tactile signals are limited or missing altogether, a certain amount of information about the world around us is lost. Some of these signals can be replaced. It is believed that blind people hear better. In reality, however, they simply learn to interpret and use other stimuli more consciously. However, this does not always work in the same way. The later the age at which we lose a sense, the more difficult it is to learn to compensate for it with other senses. There are also signals that cannot be replaced without a properly designed environment

or technical solutions. This includes the inability of blind people to use visual information or of deaf people to use voice messages.

The role of the architect and designer is to seek solutions that address these constraints.

SIGHT

Sight enables us to recognise our surroundings, objects, assess distances, hazards, time of day, or read information and signals or get feedback on the correct use of a device.

Sight reaches the furthest of all our senses. For centuries, humans have used light signals to communicate across distances. Thanks to our eyes, we can even reach stars millions of light years away.

However, our eyesight works in different ways. Some people cannot see at all, others have reduced acuity or visual field. It is assumed that in a visually impaired person, the visual acuity is limited to 0.05-0.3 of the acuity of the functioning eye or the visual field does not exceed 30°. In a person with good eyesight this is approximately 180° horizontally and 120° vertically. A blind person, on the other hand, has no sense of light, their visual acuity is less than 0.05 or their field of vision is no greater than 20°³.

The orientation skills of people who are blind from birth will usually be better than those of blind people. It is a myth that all visually impaired people are able to read Braille lettering and use tiffographic plans, otherwise known as tactile plans. Less able to do so are people who have lost their sight during their lives. The need to read Braille is also being superseded by modern technology, such as the reading and sounding software available on smartphones, or audio markers.

However, this does not mean that the use of tactile information can be completely abandoned.

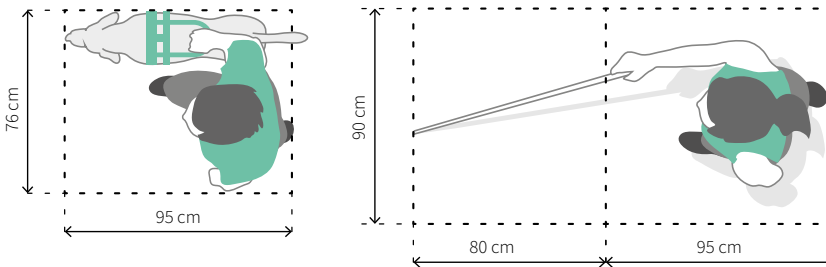

Space occupied by blind people – with and without an assistance dog. Compiled on the basis of E. Kuryłowicz, *Universal Design...*

³ Blind, partially sighted or blind? Definitions under a magnifying glass, in: pzn.org.pl, [accessed: 23.02.2024r].

It could also be that our vision is limited in the central field (this is where we see most acutely) or peripherally (this is where we gather information about approaching danger), we do not perceive differences between certain colours (e.g. daltonism), we do not see an image three-dimensionally or we perceive contrast less well. As we grow older, we gradually lose the ability to accommodate the lens of the eye for close-up vision. A child is able to read a book positioned right in front of their nose, but as we get older we have to move it further and further away, until eventually our arm proves too short.

As we age, our lens yellows and the eye finds it increasingly difficult to adapt to rapidly changing light conditions.

In architectural design, we can respond to these constraints by designing clear circulation systems, avoiding over-complicating routes, placing at the right height or protecting obstacles that can be bumped by the head. Nor can we forget to provide sufficiently large and contrasting visual information, as well as alternatives in the form of tactile and auditory information (e.g. tactile paths, tactile room markings, tiffographic plans, auditory markers, voice announcements). Information is also provided by the colouring of the space, e.g. noticeably differentiating the colour of the walls from the floors or highlighting doors. Excessive patterns on the floor, on the other hand, may give the impression that there are changes of level, and too many high-gloss surfaces or mirrors will make orientation difficult and cause accidental light reflections.

The answer to the difficulty of adapting to changing light conditions is provided by the large glazed entrance lobbies of the buildings, which, thanks to good natural lighting, give our eyes time to get used to less light inside the building.

HEARING

It is no coincidence that fire safety experts prescribe the use of audible alarms. Unlike a visual signal, sound is difficult to ignore. At the same time, however, it is much more difficult to determine precisely the direction and distance from which such a message reaches us. The distance from which sound signals are received is also limited.

Hearing enables us to gain information about changes in our environment – the arrival of a lift, the opening of a door, the movement of people, the strength of the wind. Thanks to our ears, we understand voice messages. However, if we do not pay attention to the beginning of the message, we may not understand it. This is why at train stations or airports, important information is preceded by a distinctive sound and repeated several times.

Hearing can be limited in various ways. There are hard of hearing people among us who can benefit from hearing aids. There are also deaf people, among whom we can distinguish Deaf people. By writing with a capital letter, they distinguish their cul-

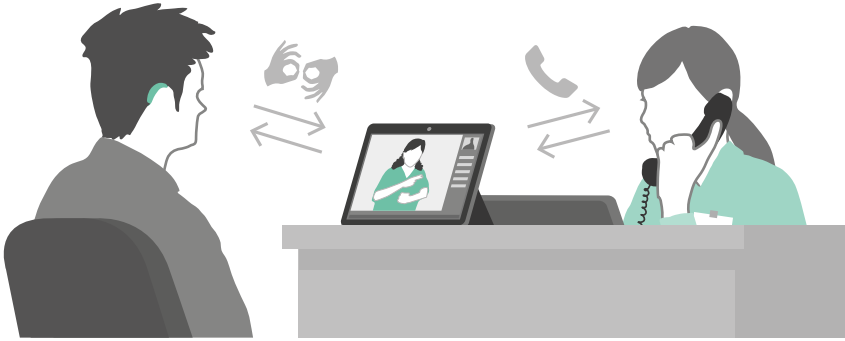

Online sign language interpreter operation diagram.

tural distinctiveness with their own language, which is Polish Sign Language. These are usually people who have not heard since birth and have grown up in Deaf culture, and Polish is a foreign language to them. However, it is important to remember that not every person who is deaf speaks sign language. As with sight loss, the later you lose your hearing, the more difficult it is to acquire new skills. Both the hearing-impaired and the deaf can be assisted by lip-reading, but this is not the rule.

As we get older, we hear the high notes less and less. It can be easier for older people to understand a man than a woman. We live in noisy environments, which can cause a variety of hearing damage or tinnitus.

It is interesting to note that deaf people like high gloss surfaces. Thanks to the reflections visible in them, they can see that someone is approaching behind their back.

In well-designed architecture, our hearing can perform better, including through better acoustics and noise reduction. Short messages, symbols and subtitles will be comfortable for both hearing and hearing-impaired people. For more complex communication, such as the need to talk, additional solutions such as online sign language interpretation may be needed. Such a service allows you to establish a remote connection with an interpreting service. By using a camera, screen, microphone and headphones, two-way communication can be provided. This can be helpful, for example, in reception areas. Hearing-impaired people in



Sign language interpreter symbol.



Induction loop symbol.

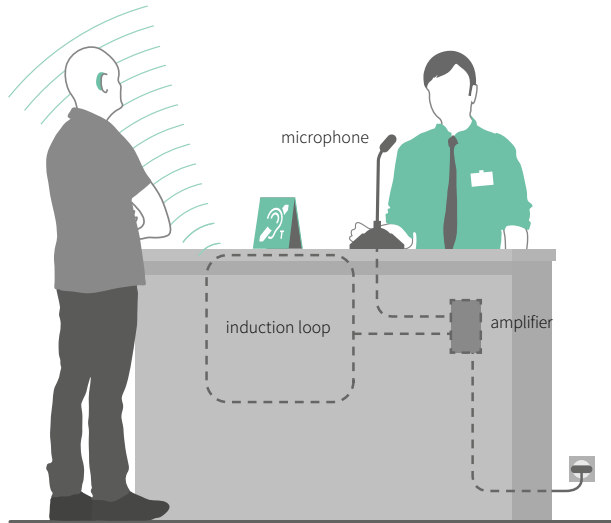

Operating diagram of a stationary induction loop (in the reception area).

places that require two-way communication, especially when there is noise around (e.g. reception areas) or the distance from the speaker is long (e.g. meeting rooms), need assistive listening systems. This uses induction loops that convert sound into an electromagnetic signal, which can be picked up directly by the hearing aid when switched to the so-called T-mode.

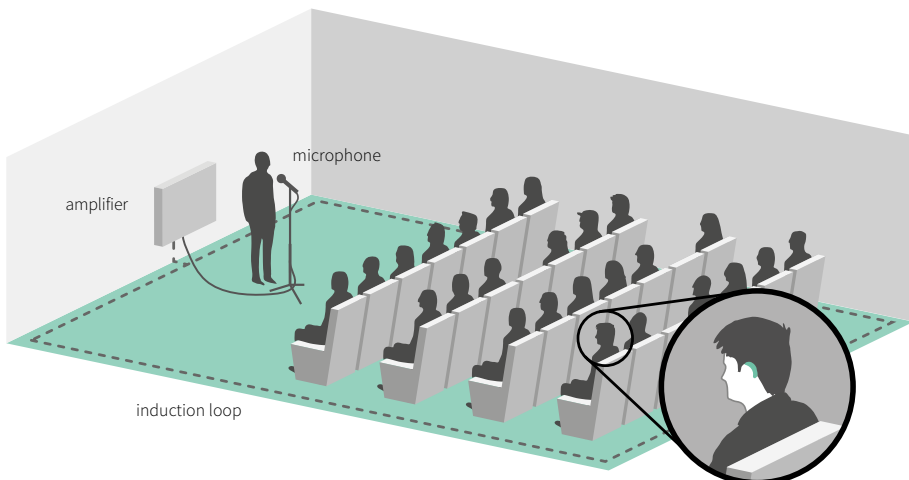

Diagram of the stationary induction loop (in the conference room).

OTHER SENSES

Other senses such as smell, taste, touch, temperature sensation and others are much less consciously used in design. However, marketing is keen to appeal to our memories, which are easily evoked by stimulating the senses of smell and taste. Smell can complement other information. It makes it easy to know when you are near a bakery or a not-so-brightly-cleaned toilet.

We can convey information through touch. This sense allows us to recognise textures, materials, temperature (even from a distance). For blind people, touch can be a very important source of information. Some can use it to recognise objects, while others can read (e.g. in Braille) or see convex plans of a building.

We can leave the impact of architecture on our senses to chance, or we can consciously design it.

A.3. Understanding

Whether we understand the space around us and the information we are given depends not only on whether our senses allow us to gain knowledge of it, but also on how our brain manages to interpret the signals we acquire.

The speed at which we process this information can vary. We may interpret them in a different way. It depends on our age, experiences and brain fitness. For a child, different signals are important than for an adult. An older person will find it more difficult to react to an unfamiliar situation. The absorption of information can be affected by intellectual disability, age, and sometimes just distraction or tiredness.

It will be difficult for foreigners to understand textual information if it has not been translated into a foreign language. Most often it will be English, but for example at railway stations near our eastern border we find information in Ukrainian or Russian.

Information conveyed through symbols will be easier for children, Deaf people and foreigners to understand, but there are also people for whom pictograms may be too abstract a message. It is therefore most beneficial to use symbols and texts simultaneously.

We can facilitate understanding by referring to familiar patterns of equipment operation, using familiar symbols, simplifying texts and avoiding complicated words.

A.4. Feeling

Feeling the world depends on our ability to perceive and understand our surroundings. How we feel in a place – whether we are stimulated, calm or nervous – depends on this. It has not been known for a long time that architecture can influence our behaviour. Walking through a tall monumental staircase and corridor, and finally meeting a clerk sitting in a huge hall behind a scaled-down desk, will make us feel a sense of awe, maybe even anxiety.

How we perceive a space and how we feel about it is influenced by a myriad of factors, such as colours, materials, the scale and proportions of the space, light, acoustics, sounds, smells and temperature. It is not always the case that a positive feeling of the surroundings goes hand in hand with the possibility of easy perception. A multitude of high-contrast elements in strong colours can be perceived as aggressive and too intense. It can introduce a sense of chaos. Too much stimulus, too much information can make it difficult to find and read the most important information, impair wellbeing and increase fatigue..

There are some people for whom an excess of stimuli is particularly troublesome. These include, for example, people on the autism spectrum, with intellectual disabilities or in mental health crisis. However, overstimulation is also difficult for children and tired adults.

It is up to the architect to find a balance between all the elements of the space, to be sensitive to the specific needs of different people.

A.5. Culture

Finally, we have left a factor that we rarely pay attention to, although the design world is full of examples showing how much influence it has on the perception of a solution. It is all about culture. Sometimes solutions accepted in the Western world are rejected in other parts of the world. What is more, seemingly better solutions are rejected for cultural reasons. The same behaviour can mean different things to different people. Edward Thitchell Hall writes in an interesting way about these phenomena in his book *The Hidden Dimension*⁴.

Culture, however, is not only a result of what part of the world we come from or what language we speak. It is influenced by one's social background, education, occupation or age..

How can these factors influence architecture? There are many examples. The most obvious is the aforementioned multilingualism of messages. In venues such as museums, the way the message is conveyed must be tailored to the audience.

At airports, you will usually find chapels prepared in such a way as to be suitable for people of different religions..

Cultural diversity will also affect the procedures implemented in the company or the type of meals available in the canteen.

Good architecture is not about designing for the average person and adapting a building to the needs of people with disabilities. Good architecture is about considering the diversity of its future audience from the start of the design process.

⁴ E.T. Hall, *Hidden Dimention*, Muza 1997.

B | GENERAL PARAMETERS

B.1. Parameters of the circulation space

ORGANISATION OF THE CIRCULATION SPACE

Basic principles of circulation space design:

- **Legibility of the circulation system** – circulation spaces inside and outside the building must be designed in such a way that users have no difficulty in finding their way around, e.g. a person entering an entrance hall should be able to easily locate the reception, access control gates, lifts and toilets.
- **Simple circulation system** – particularly important for people with visual impairments. It is advisable to design the main circulation spaces with a rectilinear route and to design changes of direction at right angles.
- **Minimising the distance** – users should travel the shortest possible distances. In order to achieve this, it is necessary that during the design of the building movement patterns are defined according to the different user groups, e.g. at the entrance to the building a different route will be chosen by an employee (bypassing the reception) and a different one by a visitor.
- **Same route for different user groups** – People with reduced mobility should follow the same routes as other people. Separation of different groups of people is permitted where there are stairs on the route – people with reduced mobility should be directed to lifts.
- **Continuity of the circulation system** – users with disabilities should not be surprised by situations in which they are unable to move on, e.g. when there are stairs at the end of a long corridor. In such a situation there should be a lift next to the stairs and, if this is not possible, this situation should be indicated well in advance and another way should be made available..

- **Maintaining the single-line principle** – if small architecture, furniture, architectural elements, etc. are placed in circulation space, it is advisable to first define a clear line which will form the boundary of the circulation space. This line can be defined by, for example, columns, recesses, furniture arranged in a repetitive manner.

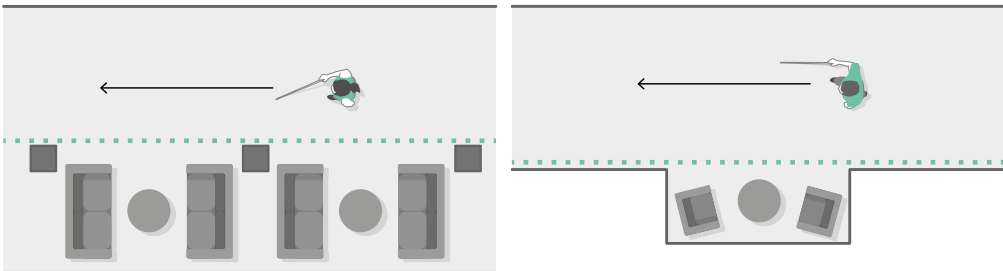

The single-line principle. All obstacles are behind a clearly defined line..

WIDTH

The width of circulation spaces must be adapted to the planned traffic volume:

- **180 cm** – allows two wheelchair users to pass each other. It should be used in all areas with constant two-way traffic.
- **150 cm** – allows a wheelchair to turn 180° and pass an able-bodied person, but does not allow two wheelchair users to pass each other. It should be used in areas where two-way traffic is common.
- **120 cm** – allows a wheelchair user to move around, but does not allow turning. Passing an able-bodied person may be difficult. Can be used in areas with infrequent two-way traffic, e.g. secondary corridors, aisles between desks or shelves.
- **90 cm** – allows a wheelchair user to move over a short distance. Exceptionally permissible in existing spaces for sections of up to 200 cm. Avoid on important traffic routes⁵.

⁵ ISO 21542:2021, section 6.3.3; ISO 21542:2021 refers the dimensions given here only to external spaces. In practice, however, they can also be applied to the interior of a building.

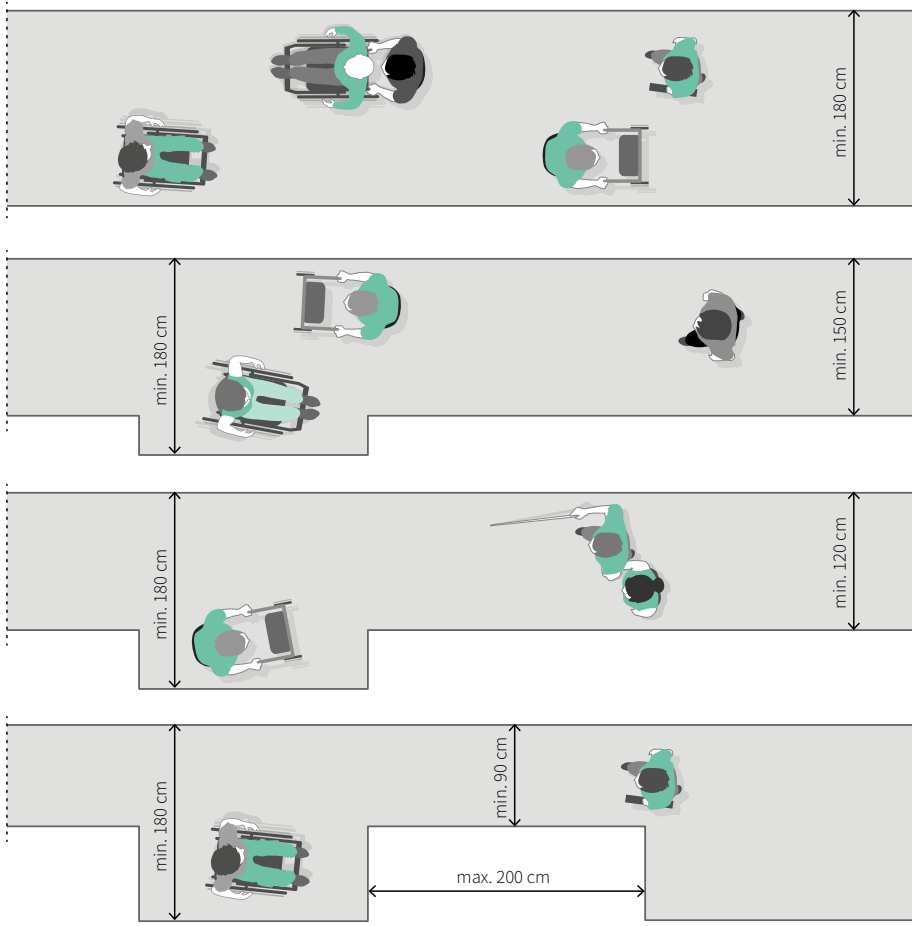

Widths of circulation space. Prepared on the basis of ISO 21542:2021.

Where the width is less than 180 cm, every max. 20 m there should be spaces to allow wheelchair users to pass each other. Such spaces should be no smaller than 180 x 200 cm⁶. In the outdoor space, additional requirements for the width of pavements result from public road regulations. For details, see section 2.1 (p. 92).

According to the regulations in force in Poland, the width of corridors inside a building should not be less than 140 cm. However, it is worth sticking to the rules described at the beginning of this chapter.

⁶ Ibid.

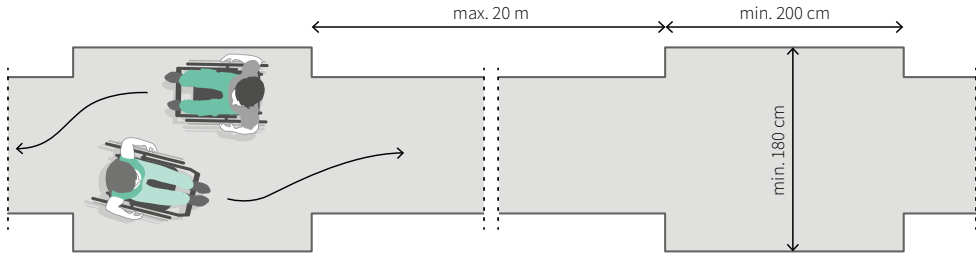

Passing place design principle. Prepared on the basis of ISO 21542:2012.

The width of circulation spaces should be measured after deducting the area occupied by furniture and other equipment. It is also important to match the width to the expected volume of traffic.

In exceptional situations, the regulations allow aisles with a minimum width of 120 cm. However, such widths should be avoided as far as possible.

In areas that require manoeuvring (e.g. at the ends of corridors, entrances to toilets for people with disabilities), it is necessary to provide spaces of min. 150 x 200 cm.

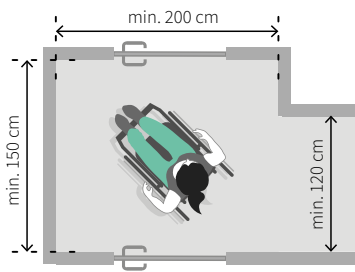

Design principle for the space at the end of the corridor

CHANGES OF DIRECTION

People in an electric wheelchair need the most space to change direction. A space of 150 x 150 cm will be sufficient for a 90° turn. With the same space it is also possible to turn the wheelchair, but it will not be a smooth change of direction. A free 180° turn will only be possible in a space of min. 150 x 200 cm⁷.

⁷ Cf. ISO 21542:2021, section G.6.2; *Building for Everyone, Inclusion, Access and Use*, National Disability Authority, Dublin 2002, s. 12.

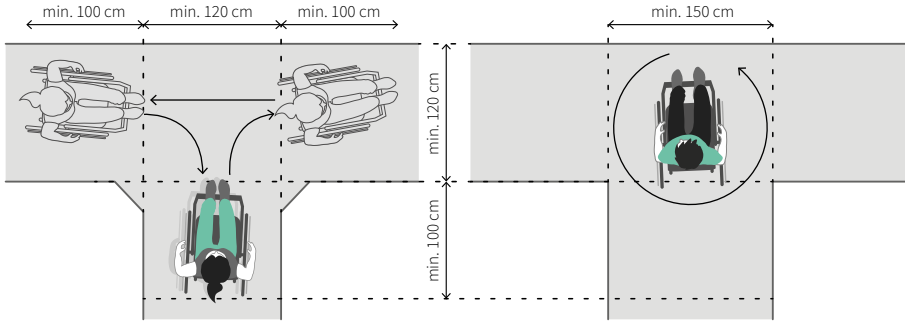

Design principle for intersections of traffic routes with different widths. Left – 120 cm wide space – a change of direction of more than 90° may require several movements. Right – at least one of the corridor arms with a width of min. 150 cm allows for a free change of direction.

HEIGHT AND SAFETY OF VISUALLY IMPAIRED PEOPLE

To ensure safety, the height of the circulation space must not be less than 220 cm. Additional requirements are set by the regulations for public roads. These are described in detail in section 2.2. (p. 95).

Hanging and projecting architectural, informational, etc. elements should be designed using at least one of the following principles:

- the bottom edge must be below 30 cm or above 220 cm,
- when horizontal, they must not project by more than 10 cm beyond the line of the column, wall or support to which they are attached,
- safety devices should be provided to prevent people from stepping under protruding elements and to make them detectable with a white cane, e.g. handrails, high curbs, suitably placed small architecture⁸.

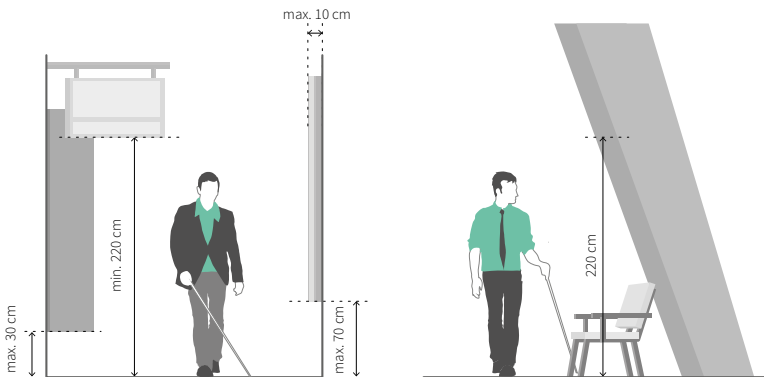

Principle of designing hanging and diagonal elements in a way that is safe for a person with a visual impairment. Compiled from ADA. Standards for Accessible Design.

⁸ Cf. ADA. Standards for Accessible Design, 307.3.

Slightly different principles may be applied when designing pillar-mounted elements.

For single pillars, at least one of the following rules must be met:

- the bottom edge must be below 30 cm or above 220 cm,
- the element must not project more than 30 cm from the edge of the pillar and its lower edge must not be higher than 70 cm⁹.

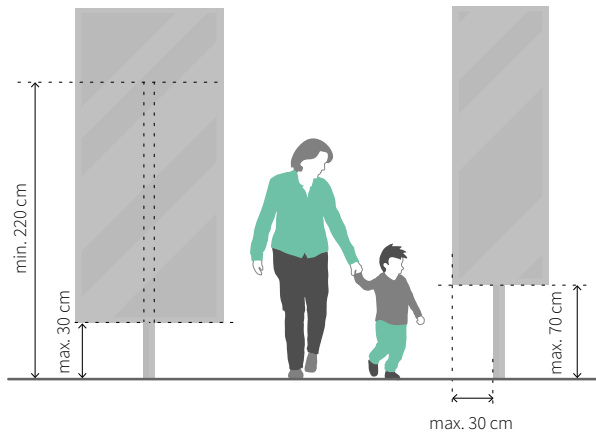

Design principle for elements placed on a single pole. Compiled from ADA. Standards for Accessible Design.

For elements fixed between pillars, at least one of the following rules must be complied with:

- the bottom edge must be below 30 cm or above 220 cm,
- the distance between the pillars must not exceed 30 cm,
- the horizontal warning elements shall be placed at a height of 20-30 cm and 70-90 cm¹⁰.

⁹ Ibid

¹⁰ Ibid.

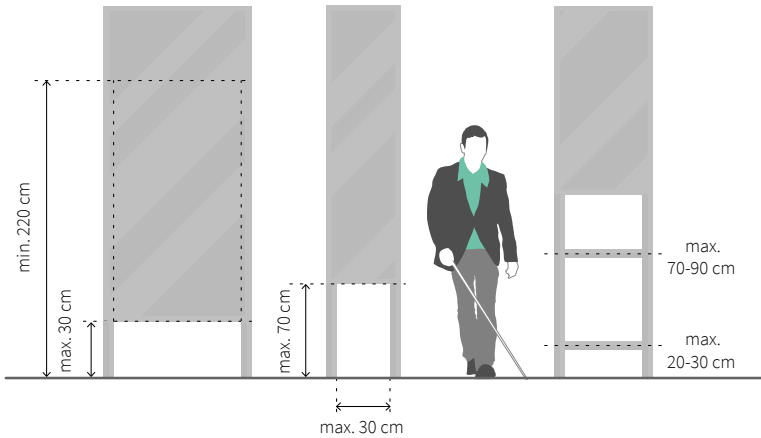

Design principle for elements placed on a double pole. Compiled from ADA. Standards for Accessible Design.

B.2. Level differences

Information on the design of level differences outside the building is given in chapter 2.3 (p. 96).

Inside the building, level differences should be designed in accordance with the following principles:

- Between floors – stairs and passenger lifts. In existing buildings, where there is a lack of space or other technical problems, lifts can be considered. This type of equipment is more difficult to use and not everyone can use it (e.g. a cyclist, a parent with a pram).
- Changes in level within a floor should be avoided. If this is not possible, ramps should be designed. In existing buildings, where there is a lack of space or other technical problems, the use of lifts may be considered.

Detailed information on passenger lifts and stairlifts is provided in Chapter 6 (p. 142).

Detailed information on the staircase is provided in Chapter 7 (p. 174).

B.3. Ramp parameters

INCLINATION

The maximum inclination of the ramp is defined by the Regulation of the Minister of Infrastructure on technical conditions to be met by buildings and their location¹¹. These parameters are shown in the table below.

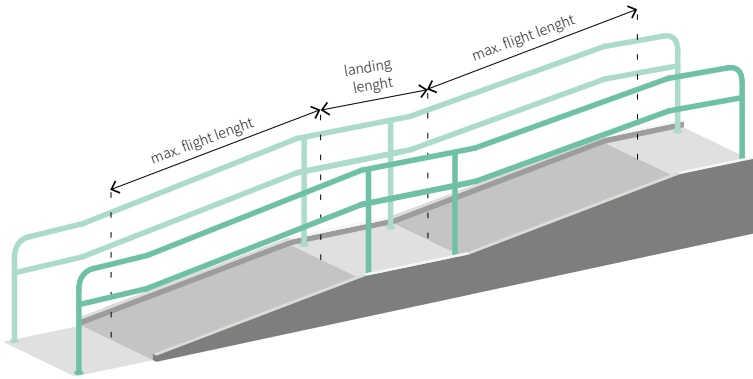

Length of the flights and landings.

Inclination of the ramp according to the Regulation on technical conditions to be met by buildings and their location

Height difference	Maximum inclination inside or under a roof	Maximum inclination outdoors, without a roof
up to 15 cm	15%	15%
15-50 cm	10%	8%
over 50 cm	8%	6%

For people with some mobility impairments, inclinations exceeding 6-8% can be difficult or impossible to overcome, so it is a good idea to limit the inclination wherever possible. The ISO 21542:2021 standard indicates that inclinations of less than 5% can be used on a section of any length, without handrails or landings¹².

¹¹ Regulation of the Minister of Infrastructure on the technical conditions to be met by buildings and their location, § 70.

¹² ISO 21542:2021, section 6.4.2.

In Poland, only the regulations for public roads allow handrails and ramps to be omitted when the inclination does not exceed 6%. An equivalent provision is missing in the regulations for buildings.

PARAMETERS OF FLIGHTS AND LANDINGS

The length of a single flight of ramps must not exceed 9 m. In the case of a longer ramp, there shall be a landing length of not less than 140 cm¹³ (150 cm recommended).

If there is a change of direction of at least 10° on the landing, the dimensions of the landing must not be less than 150 x 150 cm¹⁴.

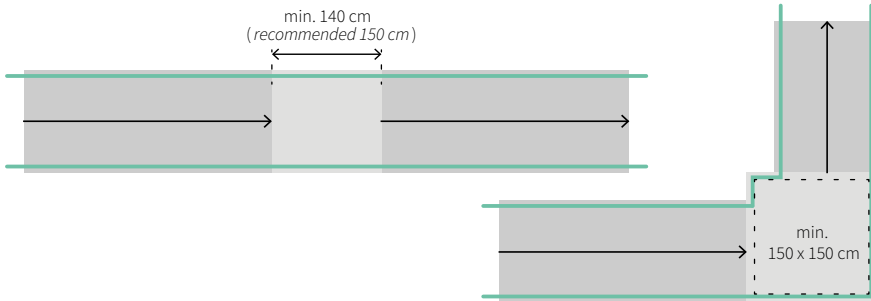

Size of landings when moving forward or changing direction below and above 10°.

The width of the ramp must be 120 cm. If the ramp is wider, a 120 cm wide lane shall be provided for the movement of persons with reduced mobility¹⁵.

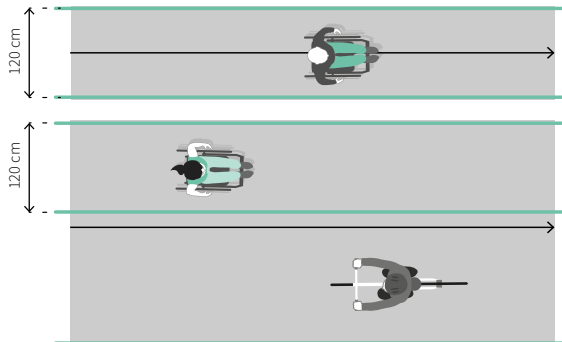

Width of ramp. Two variants – a 120 cm wide ramp and a wider ramp with a designated handrail lane for people with disabilities.

¹³ Regulation of the Minister of Infrastructure on the technical conditions to be met by buildings and their location, § 70.

¹⁴ ISO 21542:2021, section 6.4.4.

¹⁵ Regulation of the Minister of Infrastructure on the technical conditions to be met by buildings and their location, § 71(1)

On the open side of the ramp, a curb of min. 7 cm or other architectural element, e.g. a wall, shall be provided to prevent the wheelchair from falling off the ramp¹⁶.

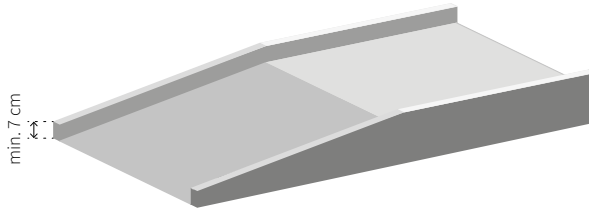

Curb at the ramp.

A horizontal manoeuvring space of not less than 150 x 150 cm shall be provided at the top and bottom of the ramp (in front of the flights). This space must not be restricted by any obstacles, including the opening area of the door (the section of the circle defined on the floor by the opening door)¹⁷.



Manoeuvring spaces behind and in front of the ramp.

HANDRAILS

Handrails along a ramp or dedicated lane for persons with reduced mobility should:

- be provided on both sides,
- have a spacing of 100-110 cm,
- be at a height of 75 and 90 cm,
- be parallel to the motion plane and to the landings,
- be installed at least 5 cm from a wall or other obstacle,
- in the case of external ramps, be extended by 30 cm beyond the run of the ramp (extension is also recommended for internal ramps)¹⁸.

Other handrail parameters are given in Chapter 7.3 (p. 177)

¹⁶ Ibid.

¹⁷ Ibid, § 71(3).

¹⁸ Ibid, § 71(1), § 298(4), (5) and (6).

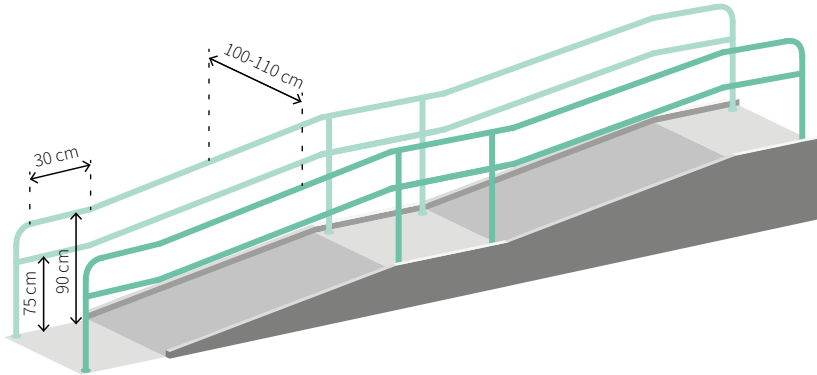

Positioning of handrails at the ramp.

VISUAL AND TACTILE MARKINGS

Visual and tactile markings are less important on ramps than on stairs. They are worth using when the inclination of the ramp is greater than 5%.

Contrast stripes should be located along the top and bottom edges of each ramp run. Their width should be 5-10 cm. The contrast shall comply with the principles described in subchapter LRV (p. 54).

Tactile warning signs should also be provided at important circulation locations. For more information on tactile markings, see p. 70.

B.4. Doors

TYPES AND METHOD OF DOOR OPENING

Doors can be divided according to the type of leaf and the way they open.

The advantages and disadvantages of the different solutions are shown in the tables below.

Advantages and disadvantages of doors by type of leaf

Door type	Advantages	Disadvantages
Hinged	Correctly designed and manufactured, present no significant obstacle for most people.	To ensure full usability, it is essential that the right parameters are maintained: <ul style="list-style-type: none"> • manoeuvring space next to the door, • low force needed to open the door, • appropriate shape of the handle.

Door type	Advantages	Disadvantages
		The door leaf interferes with the circulation space and therefore this type of door may cause some difficulties for visually impaired people.
Sliding	They do not interfere with the traffic space and are therefore the most favourable from the point of view of visually impaired people.	In the case of manually opening doors, it may be necessary to hide the handle in the surface of the leaf. Such a handle is difficult to grasp for people with limited hand dexterity..
Revolving	Reduce temperature transfer between the exterior and interior of the building.	In most cases they are inaccessible to wheelchair users. Cause difficulties for people with visual impairments. In the vicinity of a revolving door, it is necessary to install additional hinged doors or sliding doors.
Swinging	As the door can be pushed in either direction, it is easier to open for a person in a wheelchair.	They may have a tendency to bounce in the opposite direction, so there is a risk of hitting a passing person. It is difficult for visually impaired people to predict the direction of opening. If their use is necessary, the hinges should inhibit the movement of the leaf and prevent rebound in the opposite direction..

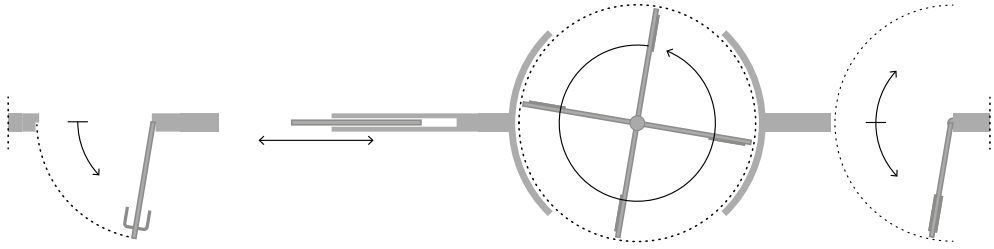

Different types of doors. From left: hinged, sliding, revolving, swinging.

Advantages and disadvantages of doors according to their method of opening

Door type	Advantages	Disadvantages
Automatic	They do not require any action on the part of the user and are therefore the most convenient type of door.	Risk of failure. Accidental opening by persons passing in the vicinity.
Semi-automatic	Opening the door requires no effort on the part of the user.	<p>Risk of failure. Visually impaired people may have problems finding the button.</p> <p>Using the button can be difficult for people with upper limb disabilities.</p>
Manually opened	Low failure rate.	<p>If the leaf weight is too high, the closer is not adjusted correctly, and there is a lot of wind resistance, it can create too much resistance.</p> <p>Difficult for people with upper limb disabilities to open independently.</p>

The right choice of door depends on many factors. In addition to user convenience, the location of the door, access control and, in the case of external doors, economic considerations such as the cooling of the building must also be taken into account. Automatic sliding doors are the most advantageous from the point of view of various people, but their use is not always possible, e.g. due to fire regulations. Swinging doors are the least favourable for people with reduced mobility.

For manually opened doors, it is extremely important to maintain adequate manoeuvring space, handle parameters and opening force. In external doors or those on the boundary of fire zones, where the door closer must overcome the force of the wind or the negative pressure generated, it may not be feasible to maintain a low resistance. In such situations, the following solutions can be used:

- Equipping doors with actuators for automatic or semi-automatic opening.
- Fitting the door with an electromagnet to hold it open – the electromagnet is released when the fire zone needs to be closed. This solution can only be used inside a building.

It is usually not possible for wheelchair users to use revolving doors and they are also an impediment for people with visual impairments. For this reason, it is necessary to provide alternative hinged or sliding doors¹⁹. In practice, such doors are regarded only as an escape route. This is a mistake. A person in a wheelchair has to wait until an employee of the facility notices them and opens the door from the inside. This is particularly inconvenient when it is raining or snowing.

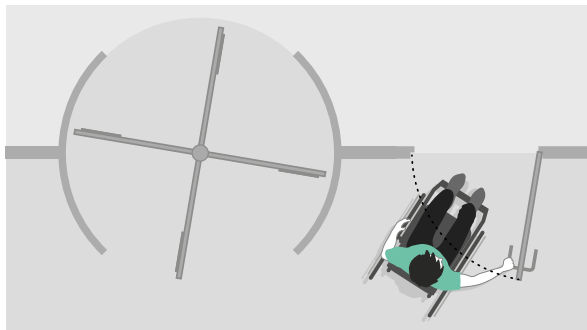

Hinged or sliding doors as an alternative to revolving doors.

¹⁹ Ibid, § 62(2).

A solution to the problem may be not to lock the door and to ensure that the door can be opened from both sides and, if access control must be maintained, to equip the door with a card reader for employees and an intercom or video intercom for visitors.

If access control is required, such doors can be fitted with a card reader for employees and an intercom or videophone for visitors.

DIMENSIONS

The width of the door, measured in the clear passage, must be min. 90 cm²⁰. In double doors, this rule applies to the main door leaf. In sliding doors, the actual passage width must be measured when the door is fully open..

If the opening width of sliding doors is reduced during the winter period, care should be taken to ensure that their minimum opening width is not less than 90 cm.

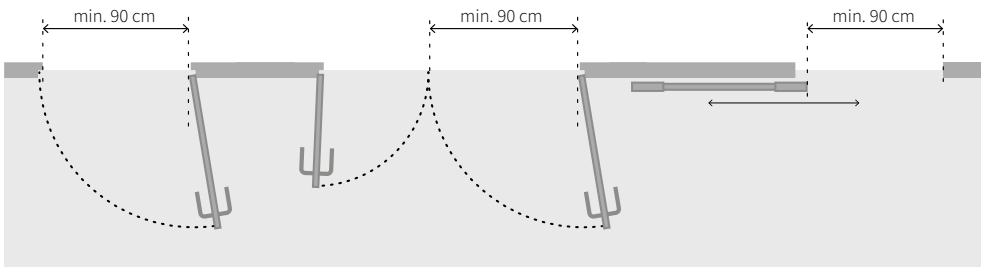

Width measurement for 3 types of doors: single-leaf hinged, double-leaf hinged, sliding.

THRESHOLDS

Thresholds to be applied at entrance doors and also to doors leading to to terraces, balconies and loggias accessible to the public must not be higher than 2 cm²¹. However, a height of up to 1.5 cm is preferable. For wheelchair users, the complete absence of thresholds will be beneficial.



Cross-section through threshold: no threshold (recommended solution), threshold up to 2 cm, 2 cm threshold with min. 10 mm on one side and chamfered min. 1 : 2 on the other side.

²⁰ Ibid, § 62(1).

²¹ Ibid, § 62(3).

If a threshold is necessary, it will be advantageous to profile the edges accordingly, e.g. by rounding (radius min. 10 mm) or chamfering at a ratio of min. 1 : 2.

In internal doors, apart from doors to technical rooms, the use of a threshold is not permitted²².

HANDLES

The shape and position of the handle affects the convenience of using the door. It is also important for people with limited dexterity of the hand or the entire upper limb.

L-shaped or C-shaped handles, as well as vertical and horizontal handrails, are easy to grasp. Horizontal handles are particularly useful in toilets for people with disabilities. Bullet- or cylinder-shaped handles, small handles or handles installed too close to the door surface can make it difficult and sometimes impossible to open the door.

In areas of particular importance to wheelchair users, it can be helpful to install panic handles (even if the door is not on an escape route) or horizontal handrails. The disadvantage of this solution is that identifying the side into which the leaf opens is more difficult. For this reason, the distance of the handle or handrail from the edge of the leaf on the hinge side should be greater than on the other side.



Various handle shapes.

The cross-section of the handle should be comfortable to grasp, so a rectangular cross-section is not advantageous. Handles with a round or oval cross-section are much easier to grip.

²² Ibid, § 75(3)

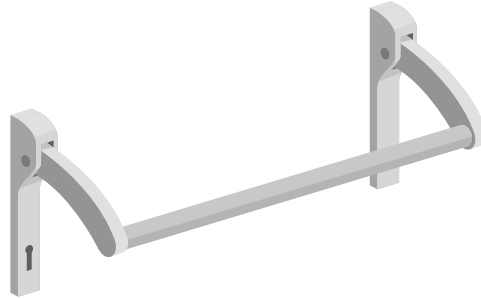

Panic handle.

The height at which the handle is installed is also important. The most favourable height is around 100-110 cm. The installation height of vertical handles, on the other hand, should at least cover a space of 80 to 120 cm.

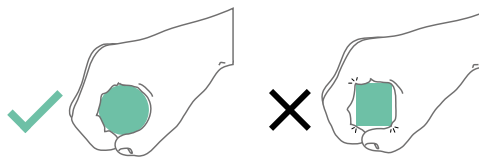

Influence of handle cross-section on grip comfort.

DOOR CLOSERS

If the door is equipped with a door closer, it must not offer significant resistance. If the force required to open the door exceeds 25 N, it is advisable to equip it with actuators for automatic or semi-automatic opening²³.

It is also advantageous to use door closers with reduced force in the opening phase and a closing delay. This allows the door to remain in the open position for a while, giving time for comfortable passage.

If the main direction of movement is parallel to the wall with the door, the door closer should not project towards the circulation space. In this situation a door closer with guide rail is recommended.

AUTOMATIC, SEMI-AUTOMATIC DOORS AND ACCESS CONTROL SYSTEMS

Door-opening sensors need to be positioned in such a way that they respond to people of different heights as well as wheelchair users. The correct positioning of the sensor is particularly important if the door is reached from the side and there is a possibility of being outside the sensor radius.

²³ ISO 21542:2021, section 9.1.1.3.

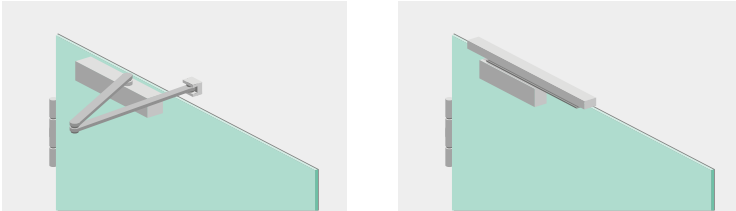

Two types of door closer. Traditional, projecting towards the circulation space – a potential hazard. With slide rail – closer close to door leaf – no danger..

If installed at the door:

- access card reader or door opener button – must be at a height of 80-110 cm,
- intercom or videophone - must be equipped with traditional buttons (for the sake of visually impaired people, touch panels are not allowed). The buttons must be at a height of 80-110 cm.

In intercoms and videophones, care must be taken to ensure that the microphone and camera are able to cover both a person sitting in a wheelchair or a short person and a person standing.

The functions of the device should be clearly marked, preferably with pictograms. Texts can be used as supplementary.

All access control devices must be located in a place that is accessible to a person in a wheelchair, among other things, they must not be closer than 60 cm from the corner of a wall. In the case of semi-automatic door opening, the button, reader or intercom used to activate the mechanism must be positioned in such a way that the opening door does not hit the person using it.

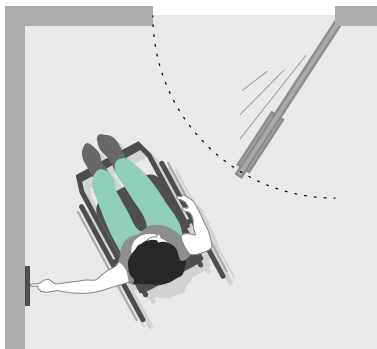

Door-opening button outside the door opening field.

MANOEUVRING SPACE BY THE DOOR

In wheelchair-accessible areas, manoeuvring space must be provided at the door to enable people to open the door independently.

If the door handle is on the corner side of the room, the free space on the handle side should not be less than 60 cm²⁴.

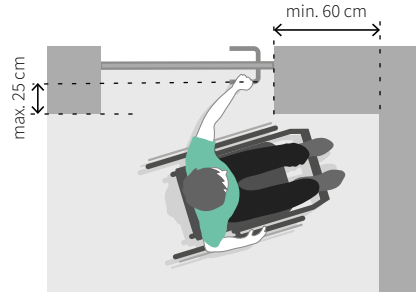

Minimum distance of the door from the corner of the room.

The parameters of the manoeuvring space at the door depend on the opening directions of the leaf and the movement of the user. The following data is based on ISO 21542:2021.

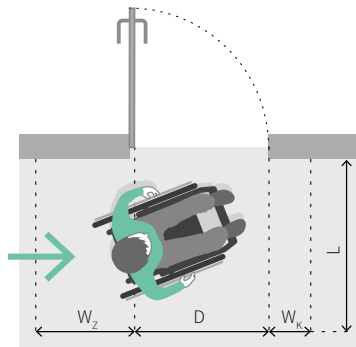

Pushing the door, direction of movement from the hinge side

Door width (D)	Width of passage (L)	Width of space at hinge side (W_z)	Width of space at the handle side (W_k)
90 cm	118,5 cm	51 cm	34 cm
95 cm	116 cm	46 cm	34 cm
100 cm	114 cm	41 cm	34 cm

²⁴ ISO 21542:2021, section 9.1.1.2.

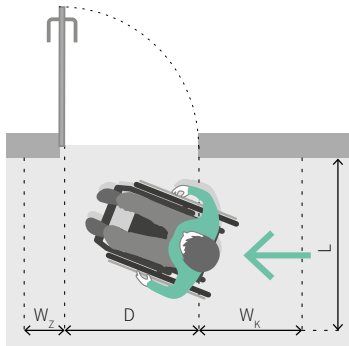

Pushing the door, direction of movement from the handle side

Door width (D)	Width of passage (L)	Width of space at hinge side (W_z)	Width of space at the handle side (W_k)
90 cm	121 cm	19 cm	66 cm
95 cm	175 cm	14 cm	66 cm
100 cm	115,5 cm	9 cm	66 cm

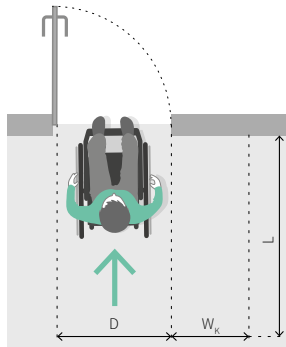

Pushing the door, direction of movement toward the door

Door width (D)	Width of passage (L)	Width of space at hinge side (W_z)	Width of space at the handle side (W_k)
90 cm	145 cm	0 cm	51 cm
95 cm	145 cm	0 cm	51 cm
100 cm	145 cm	0 cm	51 cm

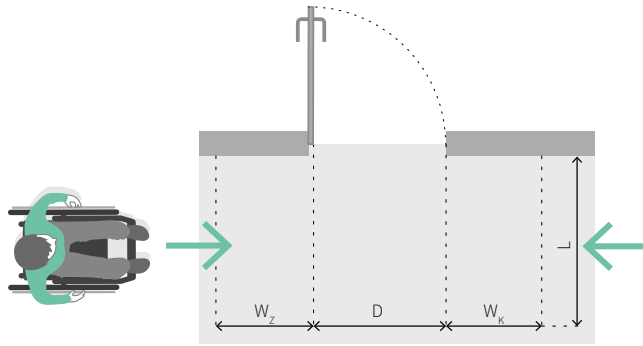

Pushing door, direction of movement from hinge side or handle side

Door width (D)	Width of passage (L)	Width of space at hinge side (W_z)	Width of space at the handle side (W_k)
90 cm	121 cm	51 cm	66 cm
95 cm	117,5 cm	45 cm	66 cm
100 cm	115,5 cm	41 cm	66 cm

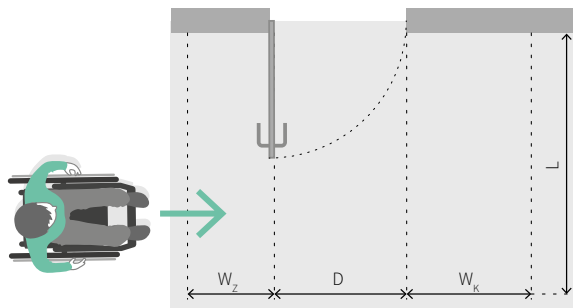

Pulling the door, direction of movement from the hinge side

Door width (D)	Width of passage (L)	Width of space at hinge side (W_z)	Width of space at the handle side (W_k)
90 cm	167 cm	61 cm	90 cm
95 cm	167 cm	56 cm	90 cm
100 cm	167 cm	51 cm	90 cm

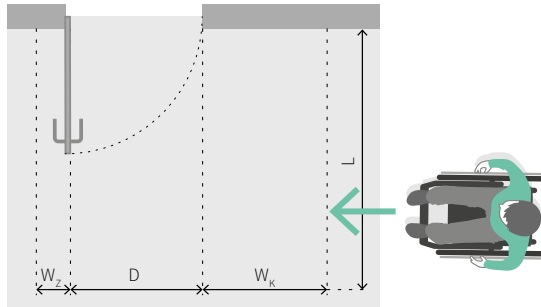

Pulling the door, direction of movement from the handle side

Door width (D)	Width of passage (L)	Width of space at hinge side (W_z)	Width of space at the handle side (W_k)
90 cm	167 cm	11 cm	90 cm
95 cm	167 cm	11 cm	90 cm
100 cm	167 cm	11 cm	90 cm

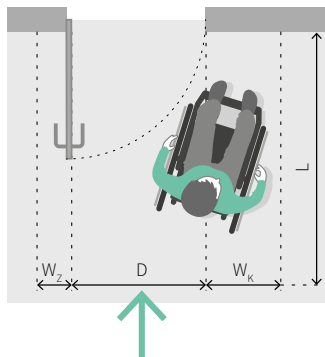

Pulling the door, direction of movement towards the door

Door width (D)	Width of passage (L)	Width of space at hinge side (W_z)	Width of space at the handle side (W_k)
90 cm	145 cm	11 cm	53 cm
95 cm	145 cm	11 cm	53 cm
100 cm	145 cm	11 cm	53 cm

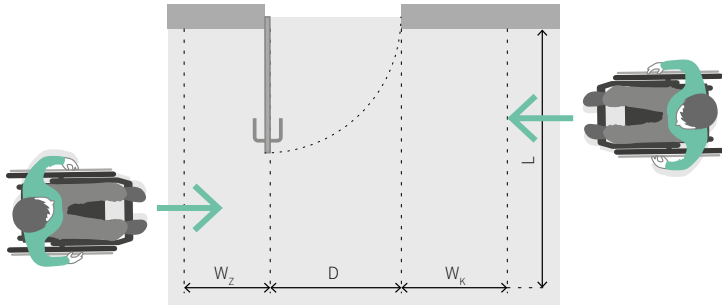

Pulling the door, direction of movement from the hinge side or from the handle side

Door width (D)	Width of passage (L)	Width of space at hinge side (W_z)	Width of space at the handle side (W_k)
90 cm	167 cm	61 cm	90 cm
95 cm	167 cm	56 cm	90 cm
100 cm	167 cm	51 cm	90 cm

B.5. Materials and colour schemes

FLOOR SURFACE

The surfaces used must be even and slip-resistant.

If floor coverings are designed, the pile length should be as short as possible – max. 20 mm, and the carpet should be as hard as possible. Long pile lengths and a soft surface will make it more difficult to move around in a wheelchair.

HIGH-GLOSS MATERIALS AND GLASS

For the benefit of the visually impaired, large high gloss surfaces should be avoided, particularly floors. Such materials can reflect light uncontrollably, causing glare and making orientation difficult for the visually impaired. Deaf people have slightly different needs in this regard, for whom even small reflections of the environment in the walls can allow visual orientation behind their backs.

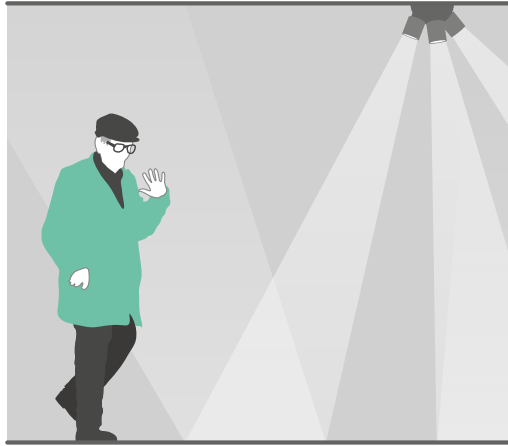

High gloss flooring – light can reflect, causing glare for visually impaired people.

Mirror design requires care. Two mirrors opposite or placed on walls meeting at an angle make it difficult to judge the size of a room and can be disorientating. Too much surface area of mirrors can also be confusing.

If doors or partitions with large glazing areas (more than 75% of the transparent area) are used at the entrance or inside the building, visible markings should be introduced on the sheet to allow users to notice the obstacle. Possible solutions include:

- a minimum of 2 horizontal strips, with a minimum width of 7.5 cm, placed at a height of 90-100 cm and 150-160 cm (muntins in doors can be considered as markings)²⁵;
- a pattern covering more than 25% of the surface of the door or wall.



Marking examples of partitions and transparent walls.

²⁵ ISO 21542:2021, section 9.1.1.4.

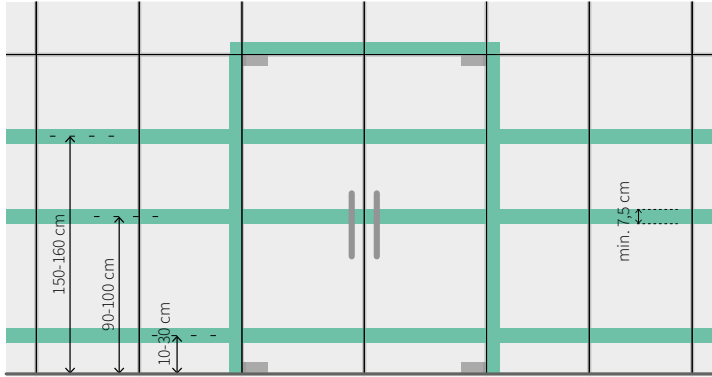

Principle of contrasting signage for transparent doors and walls. Own compilation based on the standard ISO 21542:2021.

According to ISO 21542:2021, the contrast of the marking on the glass with respect to the background must be at least 30% (calculated using the Michelson formula)²⁶. For more information on the calculation of contrast, see the subchapter LRV Scale (p. 53).

In practice, however, it is difficult to determine unequivocally what is the background to the marking on the glazing. We may be looking at it from different perspectives, and the glass itself may have different tint and clarity. In addition, the situation is made more difficult by lighting conditions, which can completely alter the perception of the marking – different during the day when it is brighter outside than inside the building, different at night when the situation is the opposite.

Markings can be omitted if there is furniture, lawn or other elements on at least one side of the wall suggesting that there is no passageway.



Furniture restricts access to the wall – marking is not necessary.

²⁶ Ibid.

CONTRASTS

For visually impaired people it is important to maintain appropriate contrasts between elements of a space, e.g. between

- floors and walls,
- the door leaf or frame and the wall – when this is not possible, a chiaroscuro (e.g. recessing the door into the wall or clear panels in the door) can also be a solution,
- furniture and its surroundings.

The minimum contrast level between such surfaces should not be less than 30% (calculated according to the Michelson formula – see below for more information)²⁷.

LRV (LIGHT REFLECTANCE VALUE)

LRV – *Light Reflectance Value* – is a parameter that determines how much light is reflected by a given surface. Light surfaces reflect more, dark surfaces less. The LRV value can range from 0 to 100, where 0 means pure black (no light reflected) and 100 means pure white (100% light reflected). LRV is equivalent to the Y value in the CIE colour system.

The LRV value is easiest to check for colours from commonly used colour systems such as RAL, NCS, Pantone, but also colour designations used by some paint manufacturers. Relevant information can be found in good quality colour palettes, as well as on websites.

In Poland, manufacturers rarely provide an LRV for other types of natural or artificial materials, such as wood, tiles and others. However, it can be measured using a device called a spectrophotometer.

On the basis of the LRV of two surfaces, the contrast between them can be measured. The following formulae are used for this²⁸:

Michelson formula (architectural elements, furniture and warning signs):

$$C_m = (LRV_1 - LRV_2) / (LRV_1 + LRV_2) * 100\%$$

Weber formula (information):

$$C_w = (LRV_1 - LRV_2) / LRV_1 * 100\%$$

Note: Always enter the LRV of the lighter surface as LRV1.

²⁷ ISO 21542:2021, section 5.3.2.

²⁸ Ibid, appendix E.

Minimum contrast based on Michelson and Weber formulae. Compiled from ISO.21542:2021, clause 5.3.2.

Place	Formula	Minimal contrast	Min. LRV of lighter surface
Large surfaces (e.g. walls, floors, doors, ceilings), elements facilitating orientation or movement (e.g. handrails, door fittings, tactile paths, glazing markings)	Michelson	30%	40
Hazards (e.g. step edges), small components (e.g. switches and other controls) visual information	Michelson	60%	50
Information	Weber	75%	70

B.6. Electrical installation, access control devices, lighting

The height range at which control devices such as light switches, air-conditioning controls, bells, intercom buttons should be located is determined by comparing the lower upper limb reach of a tall standing person and the upper limb reach of a person with limited upper limb mobility in a wheelchair. The range thus calculated is 80-110 cm²⁹.

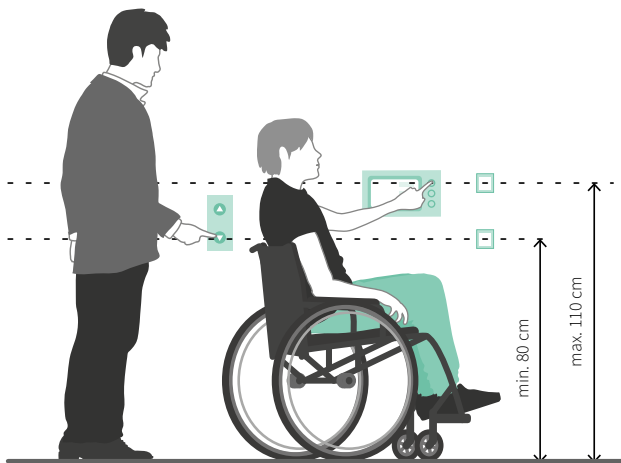

Installation height for control panels, light switches, door release buttons, access card readers.

²⁹ Cf. ISO 21542:2021, section 9.2.2.

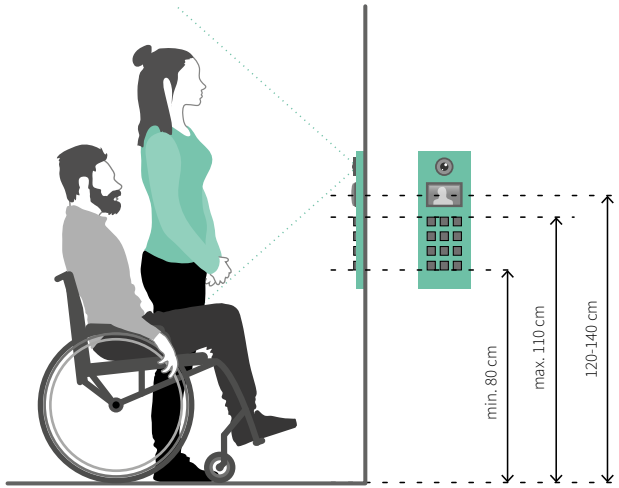

Installation height of intercoms and videophones. In addition to the correct placement of the buttons, the range of the camera, microphone and loudspeaker is important.

Control signals and displays, unless they are touchscreens, should be located higher, at a height of 120-140 cm³⁰. When selecting an intercom or videophone, consideration should be given to the range of the camera and microphone.

For employees, it is convenient to have sockets located in the tabletop or on the wall above the desk. This way, the employee will not be forced to bend under the desk, for example to plug in the telephone.

The distance of light switches, control panels and access control devices from the corner of the walls is also important. This should not be less than 60 cm, otherwise a person in a wheelchair may not be able to reach them.

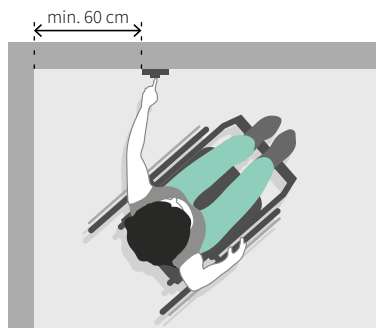

Distance of switches, access card readers, panels etc. from the corner of the wall.

³⁰ Ibid.

The lighting in the building must be uniform and in accordance with current standards and regulations. Diffuse light sources with a high colour rendering index – preferably $Ra \geq 80$ – are recommended. If directional lighting is provided, the light source must be positioned high enough to avoid dazzling users.

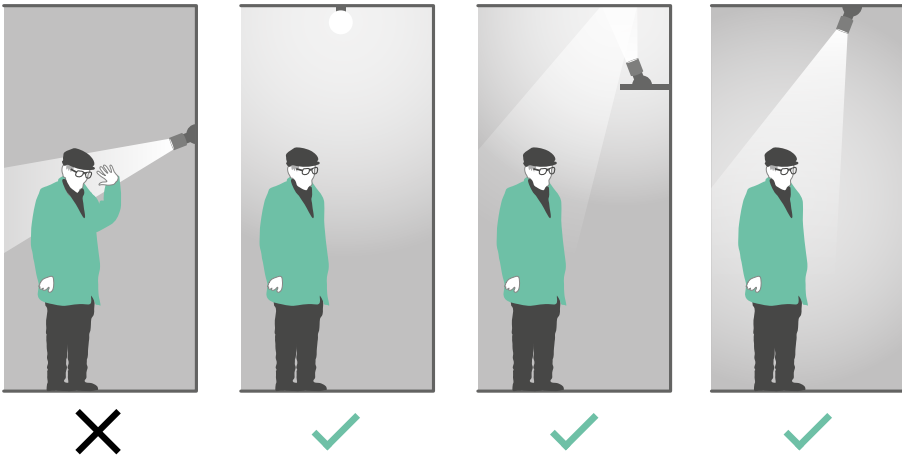

Examples of correct and incorrect lighting arrangement in buildings

In areas where conversation may be necessary, e.g. reception areas, meeting rooms or conference tables, a strong light source must not be behind the backs of the people being spoken to. When this is unavoidable, it should be possible to cover the window or counterbalance natural lighting. In this way, facial expressions will be easier to recognise, and hearing-impaired people will be assisted by lip reading.

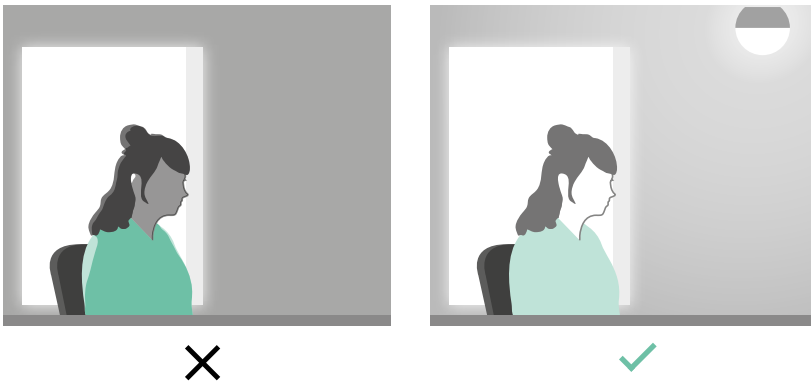

A strong light source from behind can make communication difficult. If this situation cannot be avoided, an additional light source should be provided.

B.7. Information

Information in a building should be designed to be readable by everyone, including people with visual or hearing disabilities. It is always necessary to provide a minimum of two different ways of conveying information, e.g.:

- visual and tactile;
- visual and voice.

In very small establishments (e.g. a small bank branch, post office), the information provided by an employee may be considered sufficient.

VISUAL INFORMATION

In this chapter we have described the basic principles for creating visual information in buildings. Below, you will find information that will allow you to make a general assessment of the quality of this type of information. For readers wishing to expand their knowledge, we recommend publications on typography.

Creating high-quality visual information systems requires a great deal of knowledge about the legibility of typefaces, using them appropriately for the situation and meaning, text composition, colouring, human behaviour and cultural aspects. When designing visual information systems, it makes sense to work with professionals.

The information presented here is applicable to visual information used in architecture. In the case of publication typesetting, poster development or digital applications, maintaining legibility may require slightly different solutions.

The legibility of a particular symbol or inscription depends on a number of interacting factors. These include size, contrast, proportion, line thickness and, with regard to texts, also the choice of typeface, degree of typeface or inter-letter spacing. It sounds complicated and in fact it is. It would be an oversimplification to say: this lettering is better because a sans-serif typeface was used, or: it is more legible because it is larger.

Information designed for an office building will be different from that designed for a museum or an airport. The complexity of the visual information system will also depend on the size and complexity of the building.

The information presented below is based on:

- Norm ISO 21542:2021,
- Norm DIN 1450:2013,
- website: www.leserlich.info,
- website: www.grafmag.pl.

LEGIBILITY OF SYMBOL TYPEFACE

Among the factors influencing the legibility of the typeface we can mention.:

- **recognisability** – more legible are typefaces that we know well and use every day. Low recognisability is characterised by handwriting or over-complicated typefaces, the use of which in information is inadvisable;

Abc

simple typeface

Abc

stylized typeface

- **variety of letters** – greater variety of letters makes them easier to recognise;

a g q
I I

typeface with repeatable
letter structure

a g q
I I

more readable typeface,
better letter recognition

- **proportions** – Letters of the same size expressed in points may have different legibility depending on the height of the letter (known as x-height), measured as the distance between the base and centre line of the typeface. In practice, using a typeface with a lower x-height will require it to be enlarged. For more information on measuring the size of letters, see the following pages;



- **serif** – sans-serif typefaces are considered more legible for building information. However, research shows that the advantage is not disqualifying for serif typefaces³¹. The legibility of a poor quality sans serif typeface may be less than that of a well-chosen serif typeface;

Toaleta
Toilets

sans-serif typeface

Toaleta
Toilets

serif typeface

- **aperture size** – larger aperture typefaces are more legible, this is particularly noticeable when visual acuity is reduced, or the lighting is too strong or too weak;

a e s

typeface with closed aperture

a e s

letters with open aperture,
better readability

- **stroke thickness** – the stroke thickness of a letter or symbol should not be too thin (blending with the background even when the contrast is good), nor too thick (blending into a uniform spot). The most legible letters are those in which the thickness of the basic line is 10-20% of the central height;

→ Planetarium
← Laboratories



→ Planetarium
← Laboratories



→ **Planetarium**
← **Laboratories**



- **contrast between the strokes** – monolinear typefaces or those in which the difference between thin and thick strokes is small are more legible.

Abc

monolinear typeface,
little or no contrast

Abc

medium contrast typeface

Abc

high contrast typeface

³¹ Sofia V., *Font Readability Research: Key Difference Between Serif Vs Sans Serif Font*, in: www.geniusee.com [access: 4.03.2024]

These are just a few of the factors that affect the legibility of a typeface. In facilities where a large number of visitors or visually impaired people can be expected, it is advisable to use typefaces with the best possible parameters. This does not mean, however, that a typeface which does not comply with one or even more of the above rules will be illegible.

For pictograms, it is difficult to define analogous criteria. As with letters, it is advisable to use familiar symbols. It is also best if the strokes of the pictograms are of medium thickness – not too thin (merging with the background) and not too thick (merging of the symbol elements).

LETTER AND SYMBOL SIZES

According to standards such as ISO 21542:2021 or DIN 1450:2013, text sizes are calculated based on the height of the letter (known as x-height). It is defined as the distance between the baseline and the centre line of the typeface – this is usually measured by the height of the lowercase x.

Letter height based on DIN 1450:2013.

Letters:

- minimum height (readability for visual acuity ≥ 0.7 normal acuity):
HT = $0.0026 \times L$
- recommended height (readability for visual acuity ≥ 0.5 - 0.4 normal acuity):
HT = 0.0037 - $0.0046 \times L$

Note: When using light-coloured characters on a dark background, enlarge by 10%³².

Symbols:

Symbols should be 3 to 4.5 times larger than letters.

ISO 21542:2021 gives the following formulae for calculating the height of letters and pictograms in visual information³³:

Recommended letter height:

HT = 0.02 - $0.03 \times L$ (not less than 15 mm)

HT – height of text, L – distance from text.

Recommended height of pictograms (relative to the frame):

HZ = $0.09 \times L$

HZ – wysokość znaku, L – odległość od znaku³³.

³² Calculations based on: <https://www.leserlich.info/werkzeuge/schriftgroessenrechner/index-en.php> [access: 25.10.2023].

³³ ISO 21542:2021, clauses 5.5.5, 5.6. ISO 21542:2021 recommends using formulas that take into account the visual acuity of visually impaired people (letters: HT = 0.02 - $0.03 \times L_m$, symbols: HZ = $0.09 \times L$). However, the size of signs calculated in this way is too large for practical use (at a distance of 10 m the symbol should be 90 cm high). Such a large sign or inscription will not fit within the field of sharp vision of a skilled eye.

Other factors affecting the legibility of texts and symbols:

- **hierarchy** – at the information planning stage, it is crucial to decide which signs are most important. Some of the information should be visible from a distance and some from close up. For example, in the lobby of a building we place a general sign directing to the toilets, and at the entrance we give detailed information on the location of the men’s and women’s toilets;
- **contrast** – rules for contrast selection are described in the subsection Contrast (p. 54). Both too little and too much contrast are disadvantageous. With a small difference in brightness, characters will blend into the background. On the other hand, too great a difference in brightness, especially at high light levels, can dazzle and obscure the characters.;

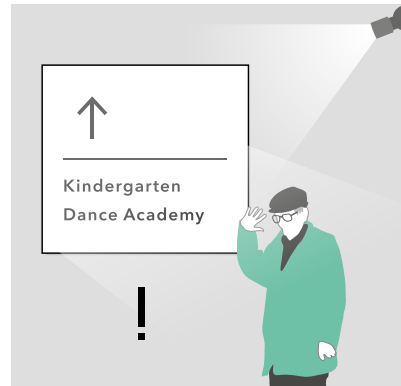

- **colours** – colours should be chosen carefully, bearing in mind that they carry coded meanings – red is an alarm, yellow a warning, green a safety/evacuation route.

Not everyone perceives colours in the same way, so combinations of green and red should be avoided (due to daltonism), and it is advisable to use other colours in addition to colour highlighting (e.g. bold text);

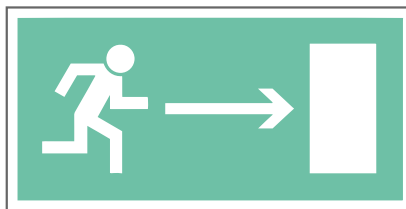

- **background** – the background should be plain and preferably not shiny;



- **letter stretching** – it is preferable to avoid condensed or stretched letters;

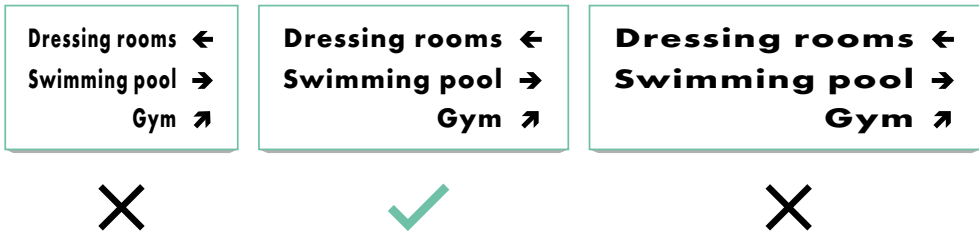

- **character spacing**, so-called inter-letter spacing, set by kerning or tracking – the spacing between letters in a word should be 35% of the centre height, and between words at least twice as much. When using a serif typeface, the spacing should be slightly larger. When using light text on a dark background, the spacing should be approximately 2% larger;



- **upper and lower case (capitals and minuscule)** – the differences between capital letters are smaller than those between lower-case letters, so it is best to start subtitles with a capital letter and continue with a lower-case letter. Words composed solely of capital letters may be considered acceptable in short captions, e.g. in directional information;

← Doctor's surgery
→ Rehabilitation room



← DOCTOR'S SURGERY
→ REHABILITATION ROOM



- **italics, bold, underline** – italicising, bolding or underlining text may reduce its readability. In some situations, however, it follows a well-known convention (e.g. underlining links) or can improve the clarity of the text structure and should not be avoided by force. In some situations, it can also enhance the clarity of the overall information;

italics
bold
underline



- **consistency** – the information system throughout the building should be consistent. If there are different directional information systems in different parts of the building, the symbols on the doors are of a different type, and in addition there are signs in many places, it will be much more difficult to recognise and understand such information;

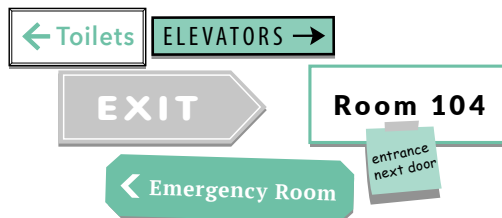

- **symbols instead of text** – first of all, it is worth using pictograms. They are easy to understand for children and foreigners – reading them does not require knowledge of the language. Texts can be used to give names (e.g. when meeting rooms have names). However, it is best to use pictograms and lettering at the same time;

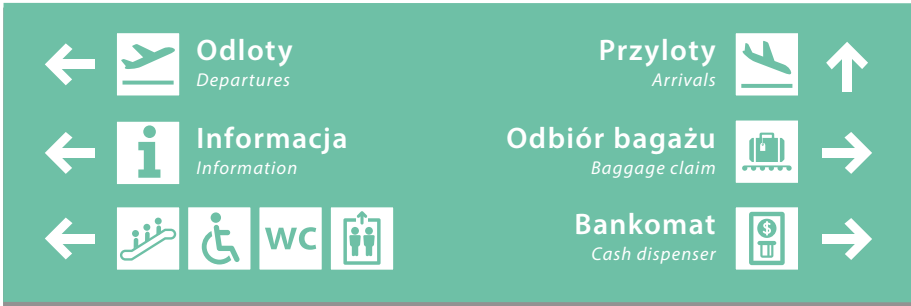

- **appropriate number of characters** – the number of pictograms including the arrow in one set of characters shall not exceed 5;



✗



- **lightning** – lighting is one of the factors influencing the legibility of signage. It is good if the illumination of the information is at least 15 lux higher than the general lighting.



✗

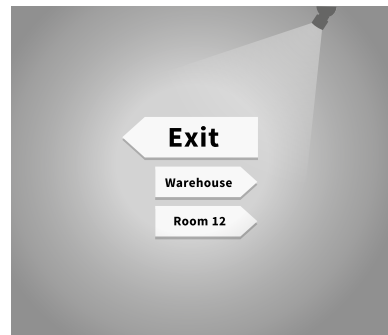

✓

DISTRIBUTION OF INFORMATION

Visual information that can be read from greater distances, e.g. directional signs, should be placed above traffic routes at a minimum height of 220 cm. 220 cm. Information that can be read at close range, such as direction signs on walls or information on room functions, should be placed at a height of 120-160 cm³⁴.

The information placed on the walls makes it possible to approach them. For visually impaired people, this enables them to see the signs from a shorter distance. If possible, it is advisable to use both solutions in a building at the same time, so that they complement each other.



Installation height of information boards

All the factors described earlier regarding the choice of typeface, size, contrast and others affect the readability of information. However, breaking one or more of the rules will not always render the information unreadable. In some situations, improving one factor can compensate for the shortcomings of another. In low light, higher contrast or larger characters may help.

Factors such as line length, line height, text justification are not included here, as their importance in the case of visual information in a building is negligible. However, they are important factors in other applications.

³⁴ ISO 21542:2021, clause 5.5.4.

TACTILE AND AUDITORY INFORMATION

Information on room functions

This type of information is placed on the door leaf or on the wall next to it. They are particularly important at entrances to toilets, staircases, office spaces, and other relevant rooms. In offices, on the other hand, this type of information can make it easier to find the room with the right number.

Tactile information placed at room entrances should be at least in Braille. It is good practice to supplement this information with a convex pictogram, room number or plain writing. Such information will be readable by people who are not familiar with Braille.

Tactile information at entrances to rooms should meet the following requirements:

- uniform distribution throughout the facility,
- possible position:
 - directly on the door leaf, above the handle (preferred),
 - on the wall next to the door, on the handle side (necessary if the door is likely to be left open frequently),
 - height 110-160 cm (close to the lower limit, check that the handle does not obstruct the reading of the marking and that the information should be inclined upwards),
- Braille in accordance with Marburg Medium or a similar standard (Braille has fixed dimensions and is not scaled),
- Braille markings close to the left edge of the label and justified to the left,
- compliance with specific spelling rules in braille (there are no separate characters for letters or numbers in braille, they are obtained by inserting the appropriate markers),
- convex letters:
 - height: 15-55 mm (measurement based on the letter x),
 - typeface: sans-serif,
 - convexity of characters: min. 0.8 mm (recommended 1 mm)³⁵.

In addition, the boards can be fitted with NFC labels/tags. This solution makes it possible to read the content with a phone from a short distance. It is still necessary to find the plaque, but the content can be read even if one does not know Braille. The advantage of this solution is its low cost.

³⁵ ISO 21542:2021, clause 5.5.9-10.



Arrangement principle for Braille information.

a	b	c	d	e	f	g	h	i	j	k	l	m	Marburg Medium standard:
n	o	p	q	r	s	t	u	w	v	x	y	z	
capital letter	ch	gh	sh	th	wh	ed	er	ou	ow	st	ing	ar	
.	,	;	:	!	?	“	”	‘	’	ı			
()	[]	/	\	-	-	-					
numeric indicator	1	2	3	4	5	6	7	8	9	0	numeric indicator 2 2 example of writing a number: 22:		

Basic Braille characters and font parameters in the Marburg Medium standard.



Example of a tactile information board.

Information on stair handrails

Stair handrails are the ideal place to place tactile information. Attached to the handrail, the information is easy to find.

The handrails usually display information about the floor number and the direction in which the stairs lead. The person leaving the staircase can also be given the most important information about the space opposite, to the right or to the left.

This type of information in Braille is written on the top of the handrail or on the side of the wall and may be supplemented with arrows pointing in the direction. The handrails can also be provided with regular raised letters for those not familiar with Braille. However, there is usually not enough space for these.

Tiflographic plans

Tiflographic plans enable a visually impaired person to see the layout of an object.

Placed on the outside of a building, they may be applicable to clusters of buildings located on a large site or parks. Installed inside a building, they will be particularly relevant in facilities with complex circulation systems. They are most often installed in train stations, airports, metro stations or visitor spaces. In office buildings, their importance is less, as it is usually possible to easily obtain assistance from a receptionist or security officer. In addition, office buildings are most often used by employees who are quite familiar with the traffic layout and room layout. It should also be borne in mind that not every visually impaired person will be able to read this type of plan.

The touchscreen plan can take several to even several tens of minutes to read, so it should be installed at an angle of 20-30° with respect to the horizontal, and its front edge must be at a height of min. 90 cm³⁶. Such a position allows the visually impaired person to rest his or her hands comfortably on the board and read the content presented.

With some technologies, such as polymer casting or milling in plastics, and some 3D printing, it is possible to combine tactile plans with visual plans that are readable by the able-bodied. In some situations, it may be more beneficial to produce multiple plans using technology that allows a blind person to take them home.

The development of tiffographic plans requires specialist knowledge, so their design should be entrusted to specialists.

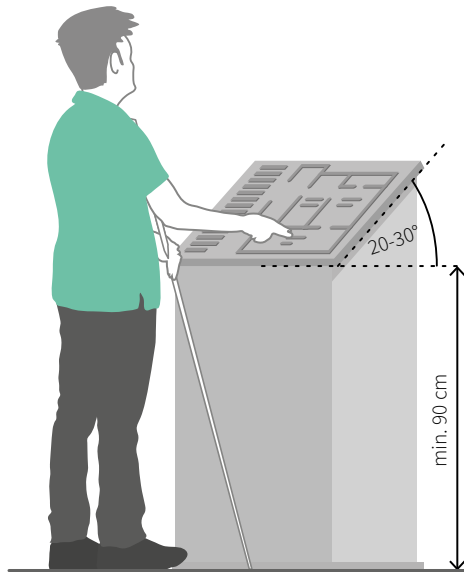

Tiffographic plan.

Tactile pathways

Tactile pathways are convex horizontal signs that can safely guide a visually impaired person between specific locations or warn of hazards.

Two types of markings are used:

- guiding elements – consisting of parallel lines,
- warning signs – consisting of convex points, known as domes.

³⁶ ISO 21542:2021, clause 5.5.13.

Outside the building, tactile paths are worth designing on wide pavements (more than 3-4 m), along streets with heavy traffic or as elements leading to pedestrian crossings and public transport stops.

An overly complex layout of tactile pathways can be misleading, so they should be designed with care.

Instead, the parameters of the designations are worth aligning with urban accessibility standards.

Inside the building, the use of paths is justified in very large entrance halls or when access to the reception area can be complicated. In these situations, tactile paths can run from the building entrance, reception area, toilets, lifts.

Warning signs should be used at the edges of pedestrian crossings, at intersections of guiding elements, in front of stairs (especially those located outside staircases) and at other places where it is necessary to warn a visually impaired person of the approach of an obstacle or hazard.

Parameter of guiding elements

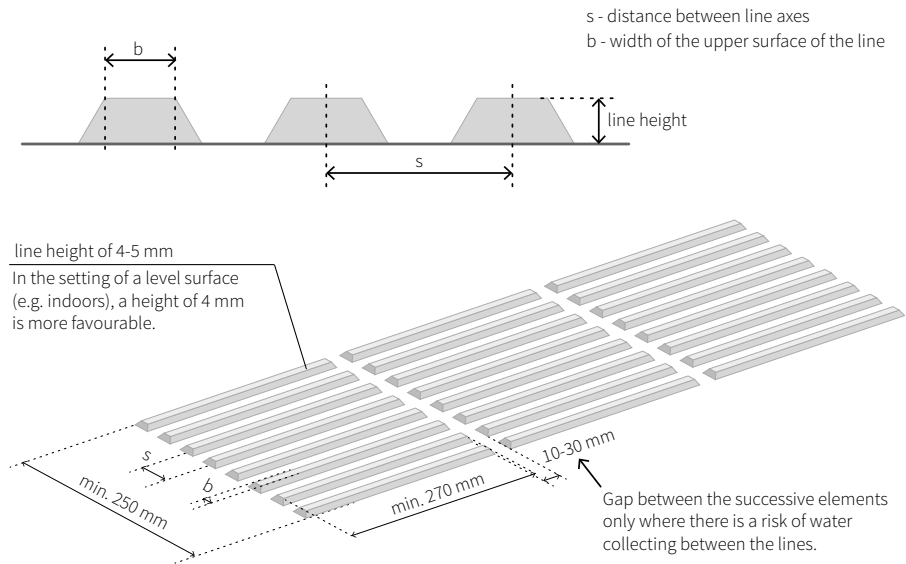

Guiding elements made with trapezoidal lines. Prepared on the basis of ISO 23599:2019.

Width of top edge of line	Distance between line axes (s)	Width of line base (b)
17 mm	57-78 mm	width of top edge +10 mm +/- 1 mm
20 mm	60-80 mm	width of top edge +10 mm +/- 1 mm
25 mm	65-83 mm	width of top edge +10 mm +/- 1 mm
30 mm	70-85 mm	width of top edge +10 mm +/- 1 mm

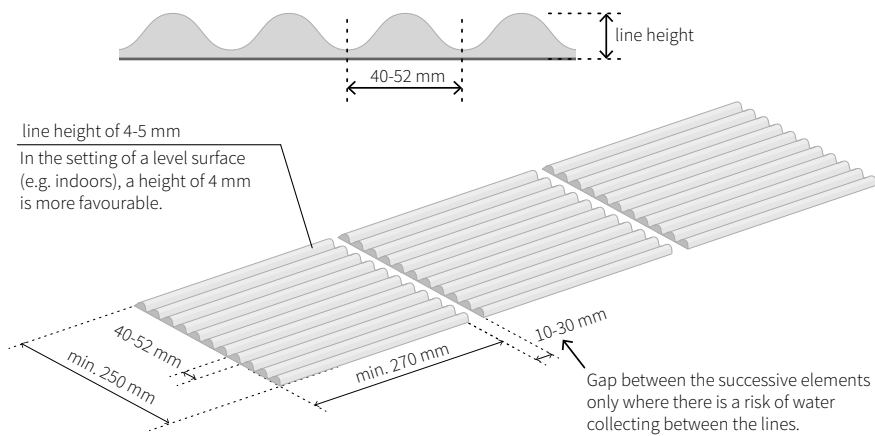

Sinusoidal guiding elements. Prepared on the basis of ISO 23599:2019.

Parameters of warning signs

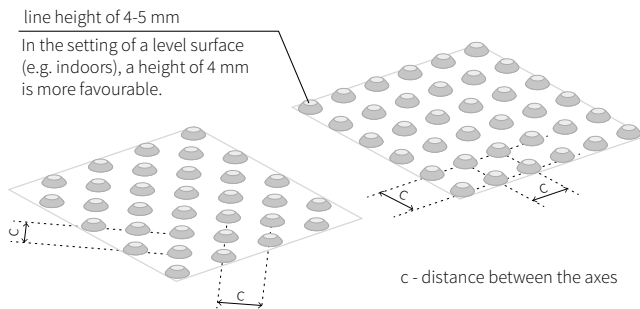

Warning signs with points in the shape of truncated cones. Prepared in accordance with ISO 23599:2019.

Upper diameter of cones	Distance between axes (c)	Lower diameter of cones
12 mm	42-61 mm	upper diameter + 10 mm +/- 1 mm
15 mm	45-63 mm	upper diameter + 10 mm +/- 1 mm
18 mm	48-65 mm	upper diameter + 10 mm +/- 1 mm
20 mm	50-68 mm	upper diameter + 10 mm +/- 1 mm
25 mm	55-70 mm	upper diameter + 10 mm +/- 1 mm

Sound markers

Sound markers are devices designed for people with visual impairments. They can be placed at the entrance or at other important points in the building. Using Bluetooth, they communicate with a phone, similar to Beacons. The difference, however, is the speaker built into the sensor. A special application detects the marker and enables the activation of a message, such as the name of the building and the entrance number. In addition, the direction can be determined from the transmitted sound.

Voice messages do not work well in noisy areas, but it is also possible to read the associated tag information directly on the phone.

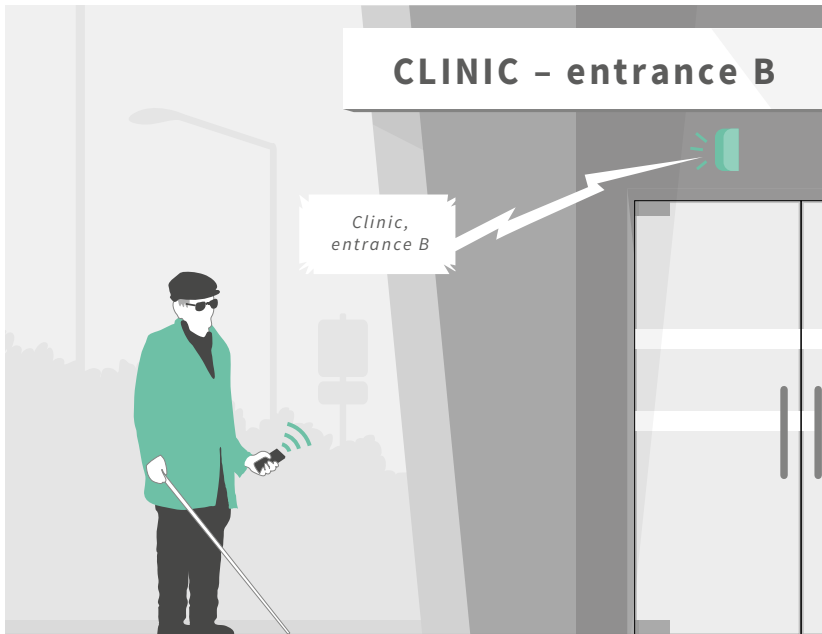

Sound marker located above the entrance to the building.

IMPORTANT PARAMETERS

PARAMETERS OF THE CIRCULATION SPACE

Minimum width:

- 180 cm – significant traffic flow, allows two wheelchairs to pass each other,
- 150 cm – slightly less important for traffic, allows the wheelchair to turn around,
- 120 cm – secondary circulation spaces, allows the wheelchair to move in one direction without turning,
- 90 cm – local constrictions of up to 200 cm should be avoided in important traffic areas.

Minimum width inside the building:

- min. 140 cm (recommended min. 150 cm),
- exceptionally, where permitted by law, min. 120 cm (not recommended).

PASSING PLACES OUTSIDE THE BUILDING (PASSING TWO WHEELCHAIR USERS) AND CHANGES OF DIRECTION

Necessary when traffic space width is less than 180 cm.

Distances between passing places: max. 25 m.

Passing space area (width x length): min. 180 x 200 cm.

MANEUVERING SPACES INSIDE THE BUILDING

In areas requiring manoeuvring (e.g. at the ends of corridors, near room entrances): min. 150 x 200 cm.

At 90° changes of direction: both roads min. 120 cm.

HEIGHT OF SPACE

Circulation space height: min. 220 cm.

Safety for visually impaired persons: see parameters described in section B.1 (p. 29).

LEVEL DIFFERENCES

External space: see information given in section 2.3 (p. 96).

Internal space:

- between floors: lifts and stairs,
- within a storey, changes of level should be avoided; if necessary, a ramp should be designed.

RAMP PARAMETERS

Height difference	Maximum inclination inside or under the canopy	Maximum inclination outside, without canopy
up to 15 cm	15%	15%
15-50 cm	10%	8%
over 50 cm	8%	6%

Length of single ramp run: max. 9 m.

Length of landing: min. 140 cm (150 cm recommended).

Landing dimensions for changes greater than 10°: min. 150 x 150 cm.

Width of ramp base: min. 120 cm.

Protection of the open side of the ramp: kerb height min. 7 cm.

Manoeuvring space in front of and behind the ramp: min. 150 x 150 cm outside the door opening area.

Handrail position: both sides, 100-110 cm apart, at 75 and 90 cm height.

Distance of the handrail from the wall: min. 5 cm.

Handrail diameter: see section B.3 (p. 38).

Contrast between handrail and wall: min. 30% (Michelson formula).

DOORS

Door width (for double doors – for main leaf): min. 90 cm.

Threshold on external doors: max. 2 cm (recommended up to 1.5 cm and appropriate profiling).

Threshold on internal doors (except in technical rooms): not permissible.

Handles: shape suitable for people with upper limb disabilities (e.g. 'L', 'C', vertical or horizontal grip).

Handle cross-section: recommended round or oval with a diameter of 19-25 mm.

Handle installation height: 100-110 cm.

Automatic door closers: if the resistance to force exceeds 25 N, the use of automatic door closers is recommended.

Sensors at automatic doors: must react to people standing and those in wheelchairs.

Manoeuvring space at the door: see section B.4 (p. 47).

MATERIALS AND COLOUR SCHEMES

Surface types: even and slip-resistant.

Pile length in floor coverings: max. 20 mm (hard floor coverings recommended, with pile as short as possible).

Finishing materials: mostly matt and semi-matt.

Transparent doors and partitions (more than 75% transparent surface): min. 2 strips of min. 7.5 cm wide, positioned at a height of 90-110 and 150-160 cm, or a design occupying more than 25% of the surface together with the door structure.

Contrast between elements of the space (walls-flooring, walls-doors, furniture-environment): min. 30% (Michelson formula).

ELECTRICAL INSTALLATION, ACCESS CONTROL DEVICES, LIGHTING

Light switches, card readers, door opening buttons, buttons on intercoms and videophones, etc:

- installation height: 80-110 cm,
- distance from wall corner: min. 60 cm,
- microphone and camera (intercoms/videophones only): with a range that includes standing and sitting wheelchair users,
- method of operation (intercoms/videophones): traditional push buttons (touch panels not acceptable).

INFORMATION

Visual information

Method of representation of information: pictograms or pictograms and inscriptions (except for information such as the name of the room, which cannot be represented by a symbol).

Contrast: min. 75% (Weber formula).

LRV of the lighter surface: min. 70 LRV.

Minimum height of pictograms and inscriptions (see section B.7, p. 58).

Highly legible typefaces recommended (see section B.7, p. 58).

Recommended wording: using upper and lower case letters (upper case alone acceptable for short information).

Number of characters per set (including arrow): max. 5.

Recommended sign illumination: min. 15 lux above ambient illumination.

Installation height of information readable from a distance: min. 220 cm.

Installation height of information read at close range: 120-160 cm.

Tactile information

Recommended types of information:

- information on room functions: installation at a height of 120-160 cm on the door above the handle or next to the door, on the handle side,
- information on stair handrails: usually the number or function of the storey, placed before the beginning of the flight of stairs.

Braille parameters: Marburg Medium standard or similar.

Parameters of regular convex signs:

- height of letters/symbols: 15-55 mm,
- convexity of letters/symbols: 0.8 mm (recommended 1 mm).

Additional types of information (relevant in facilities with complex layouts):

- tiflographic plans,
- tactile paths,
- NFC tags,
- soundtags.

Installation angle of the tyflographic plan: 20-30° in relation to the horizontal level.

Plan installation height (to the front edge): min. 90 cm.

Tactile path parameters: recommended compliance with ISO 23599:2019 or local accessibility standards (see section B.7, p. 67).





**1 | LOCATION OF BUILDING
AND RELATIONSHIP
WITH SURROUNDINGS**

1 | LOCATION OF THE BUILDING AND RELATIONSHIP TO THE SURROUNDINGS

The accessibility of a building is determined not only by its design, but also by its surroundings, its relationship to neighbouring development, access to pedestrian routes, cycling, public transport and cars. The owner's influence on the surroundings of an existing building is usually low, and any changes depend to a large extent on the policy of the local authority. However, also in the case of newly designed buildings, the interference with the surroundings is often limited to landscaping of the building plot and restoration of pavements adjacent to the development. The existing surroundings, even if they are pedestrian-unfriendly, are treated as a stagnant element with which little can be done.

More and more often we are seeing a different approach, which should become standard. Investors responsible for neighbouring developments make a joint effort and, in consultation with municipal authorities, residents and local organisations, aim to improve the quality of the space around the development. Everyone can benefit from such cooperation. The owner benefits from a well-designed and user-friendly building environment, while the municipality can renovate existing traffic routes at a lower cost. Cleverly designed, high quality space also benefits residents through parks, squares, playgrounds, access to new services and changes to the road network – new cycle paths, traffic calming on selected streets, additional pedestrian crossings, etc.

The decision to choose a development site or to interfere with the existing terrain around the building should be preceded by an analysis not only of geological, technical and economic conditions, but also of the broader accessibility of the planned facility, the possibility for people with disabilities to use the surroundings and the quality of pedestrian spaces. The most important factors influencing the accessibility assessment of a given location are described in the table below.

**Positive impact
on investment**

**Negative impact
on investment**

PEDESTRIAN TRAFFIC

	Positive impact on investment	Negative impact on investment
Landscaping	Plot located in an area without major changes in ground level.	There are significant differences in ground levels on or adjacent to the plot. It is difficult to reach the proposed building or to ensure full accessibility to some of the building entrances..
Geological conditions	Conditions to provide ground level entry without incurring disproportionate costs.	Conditions that significantly increase the cost of placing the entrance at ground level, e.g. high groundwater.
Neighbourhood	Neighbourhood of green spaces and diverse public functions and recreational areas.	Lack of green spaces and diversity of public functions, e.g. a mono-functional office district without access to services and recreational spaces.
Location of the plot	Direct access to the building from main pedestrian routes.	Plot remote from main pedestrian routes – long and very complicated access to building.
Type and condition of surrounding pavements	Level, non-slip pavements. Good state of repair of pavements.	Uneven surfaces, e.g. cobbles, granite split paving, gravel. Poor state of repair of pavements.

	Positive impact on investment	Negative impact on investment
Road system	Neighbourhood of roads of a scale suitable for pedestrian and cycle traffic. Priority of pedestrian and cycle traffic over motorised traffic.	Proximity to roads with heavy traffic, including multi-lane roads. Lack of pedestrian-friendly scale.
Availability of pedestrian crossings	Above-ground pedestrian crossings. If there are subways, provide pedestrians with a choice between aboveground and underground crossings. Underground or aboveground crossings equipped with lifts or ramps. Lowered kerbs at aboveground crossings. Tactile signage for visually impaired people at surface crossings. Audible signage at crossings equipped with traffic lights.	Underground and aboveground passages not equipped with lifts or ramps. Poor technical condition of lifts and ramps. Equipping subways and aboveground crossings with lifts instead of lifts. Priority for car traffic (pushing pedestrians to subways). At aboveground crossings lack of lowered kerbs, tactile signage for visually impaired people. Lack of audible signals at crossings with traffic lights.

BICYCLE TRANSPORT

Cycle paths	Cycle paths in the vicinity of the development.	Lack of cycle paths.
City bicycle stations	City bike stations in the vicinity of the investment.	Lack of city bicycle stations.

	Positive impact on investment	Negative impact on investment
PUBLIC TRANSPORT		
Types of public transport	Different types of public transport, e.g. bus, tram, underground, light rail.	One type of public transport or no public transport. If there is no public transport, it may be necessary to provide alternative transport for employees.
Distances from stops/stations	Short distance from stops/stations.	Long distance from stops/stations.
Availability of stops/stations	Access from passageways adjacent to the building. Access by means of above-ground passageways. Access by means of underground and above-ground passageways equipped with lifts or ramps.	Stops/stations accessible by subways and overpasses not equipped with lifts or ramps. Poor condition of lifts and ramps at subways and overpasses. Equipping subways and overpasses with lifts instead of lifts.
CAR TRANSPORT		
Parking spaces (a secondary factor for high quality public transport)	Parking spaces in the vicinity of the site or possibility to provide parking on the site, taxi rank.	Lack of parking spaces and inability to provide on site.

1.1. Pedestrian traffic

The accessibility of a building is significantly dependent on the relationship between it and the adjacent pedestrian circulation routes. Decisions about accessibility are easiest to make when designing new buildings although some adjustments to existing circulation routes are also possible in converted buildings, e.g. when redeveloping the surrounding area.

The following principles should be taken into account when planning the relationship between the building and the public space:

- **Continuity** – traffic routes should be designed in such a way that users with different degrees and types of disability do not have to divert from a pre-selected route, e.g. if there are to be stairs, the wheelchair user should notice them or be informed about them early enough to be able to choose an alternative route.
- **Transparency of traffic routes** – pedestrian routes should be as straightforward as possible, with a clear division between space for walking and space for setting up small architecture, information, street lamps, etc..

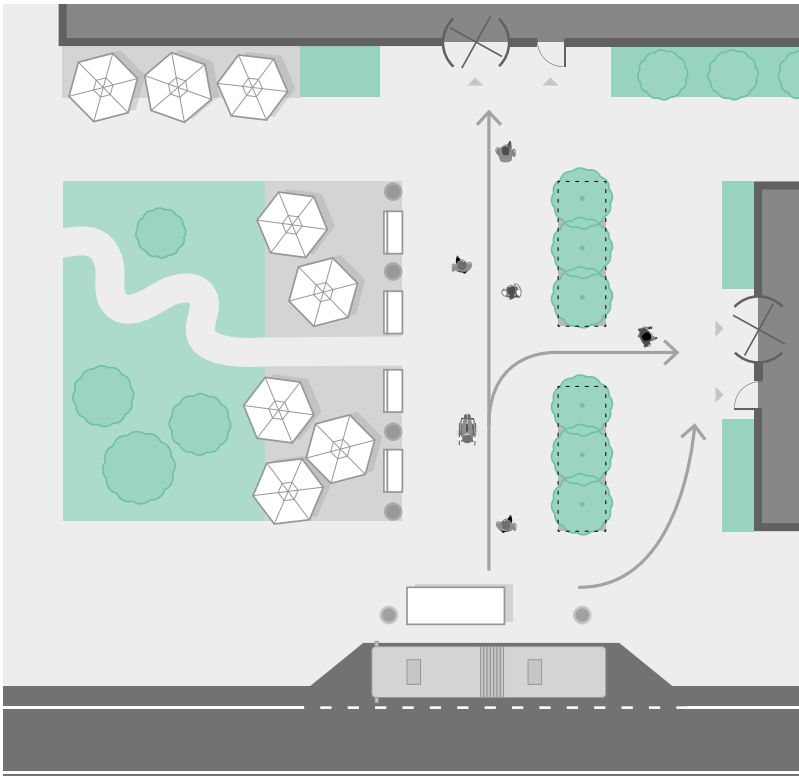

Building access plan: simple and clear stop-entry traffic, division of the wide space into narrower zones, separation of spaces for the placement of small architecture.

- **Same routes** – as a rule, all users should be led along the same routes. It is permissible to separate routes where height differences need to be overcome, e.g. stairs and passenger lift, stairs and ramp. An alternative route should be designed as close as possible to the primary route..
- **Minimising distances** – important places should be designed in such a way that the distances between them are as short as possible, with comparable distances for able-bodied and wheelchair users.
- **Relationship to landforms and location of main pedestrian routes and public transport stops** – priority in planning entrances and circulation spaces should be given to easy access to major pedestrian routes and public transport stops, e.g. where there are significant changes in ground level, entrances should preferably be located at the level of major routes and stops.
- **Differentiating the difficulty of roads** – where there are large differences in height, it is good practice to vary the difficulty of access to the site:
 - longer access with less inclination,
 - shorter access with steeper incline.

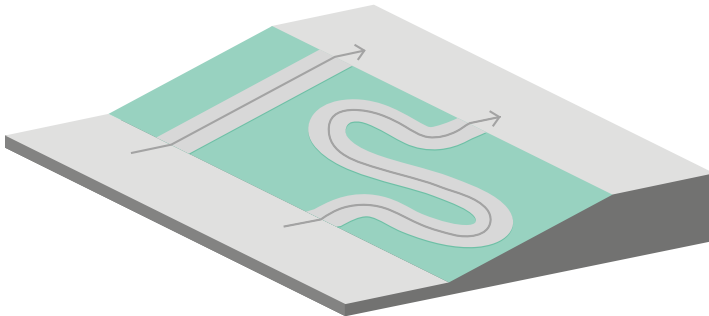

Differing difficulty of the routes. On the left, a short route with a steeper incline. On the right, a longer route with a gentler incline.

- **Unification** – repeatable solutions should be used wherever possible. This is particularly important for people with visual impairments.
- **Road hierarchy** – pedestrian – cyclist – public transport – private transport.
- **Diversified offer** – access to a variety of services, green spaces and recreational areas in the vicinity of or within the development.

1.2. Designing the traffic system versus people with visual impairments

The design of traffic routes determines the orientation of visually impaired people. Straight-line walkways make it easy to determine direction. Organically shaped footpaths, on the other hand, make orientation difficult and should therefore be avoided on main routes.

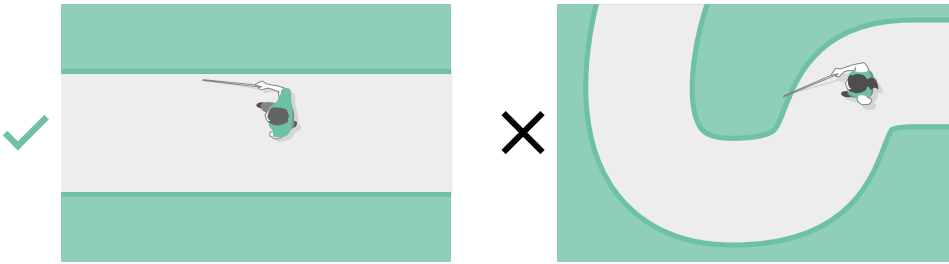

Orientation of people with visual impairments. On the right, a path with a complex layout makes it difficult to navigate and identify world directions.

A visually impaired person will find it easiest to determine directions when pavements intersect at near right angles. If it is necessary to design intersections at other angles, angles close to 45° should be aimed for. The intersection of pavements in the form of a roundabout or circular square will be a handicap for visually impaired people – navigating in a circle, it will be difficult to find the right way. Similarly, there will be too many pedestrian routes meeting each other – avoid designing intersections consisting of more than 4 roads.



Different ways of designing traffic layouts. On the right, layouts that make orientation difficult for people with visual impairments.

The width of the pavement affects the movement of a visually impaired person: the smaller it is, the easier it will be to find orientation elements along which it is safe to move, such as the kerb. With widths of more than 3-4 m, orientation can already be significantly impaired. The same is true for large, open squares. In such situations, additional orientation elements should be considered, e.g. changes in the texture of the pavement or small architecture that emphasises the main direction of traffic. It is also beneficial to divide wide traffic routes into narrower, more intimate spaces, e.g. by planting trees in the middle of the pavement or placing benches.

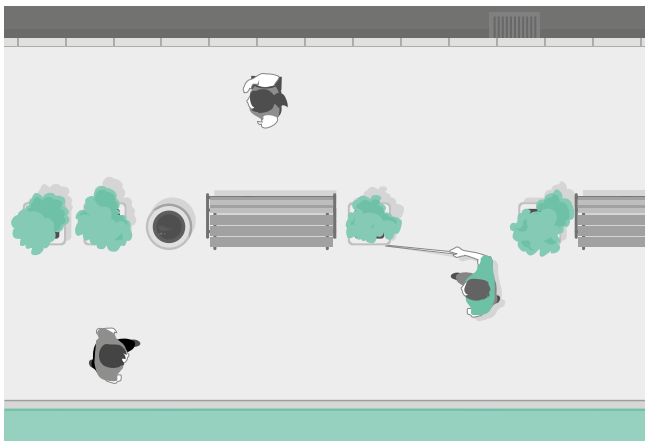

Wide pedestrian route, divided into narrower spaces by benches, trees, facilitating movement by a person with visual impairment.

According to current regulations on public roads, tactile paths are required when the width of the pavement exceeds 4m³⁷. See chapter B.7 (p. 67) for more information on this solution. It is important to note, however, that in outdoor spaces such solutions should be designed in consultation with the local authorities, according to the standard adopted in the city. In urban space, tactile paths most often lead along main streets to important transport, cultural and scientific facilities and offices, but rarely to office buildings. It is worth noting that a kerb protruding above the surface of the pavement or a change in the texture of the pavement can also provide an orientation element.

³⁷ Regulation of the Minister of Infrastructure on technical and construction regulations for public roads, § 38.

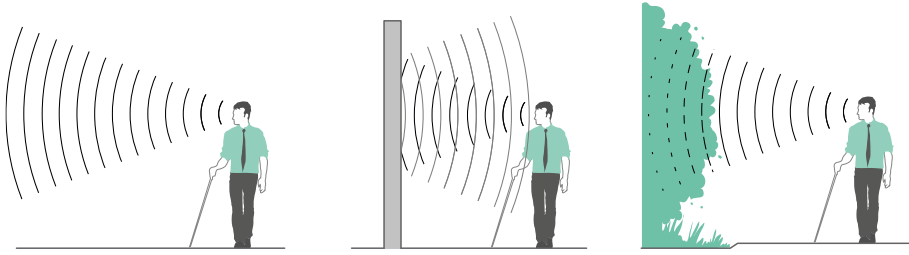

Sound propagation depending on the type of environment: open space – sound ‘escapes’; wall – reflects; vegetation – sound is attenuated.

A change in the character of the space – the resilience or hardness of the pavement, the slope, the proportions, e.g. a transition from an open space to a space enclosed by walls or surrounded by trees – can also make it easier for people with a visual impairment. Such changes can be detected with a white cane, feet or by changing the character of the sound propagation of footsteps and ambient noises, making it easier to identify where the pedestrian is.

Characteristic points that can be heard or felt, e.g. a fountain, a smell coming from a bakery, a change in sunlight, can also provide additional information. Some of these can be consciously designed, others will be the result of the use of the building and the type of activity taking place in the area.





2 | COMMUNICATION SPACE

2 | CIRCULATION SPACE

2.1. Width of circulation space

MINIMUM WIDTHS

Designing the width of pedestrian routes is influenced by the needs of different people, as well as the volume of traffic or the need to ensure an adequate level of safety. Wheelchair users will need the most space to move, turn and pass, so the needs of this group should be decisive in determining minimum widths for pedestrian routes.

According to current legislation, pavements on public roads must have a width of min. 180 cm.

In difficult situations it is permissible to limit this width to 100 cm, but on condition of providing passing places with a length of min. 200 cm and a width of min. 180 cm³⁸.

However, the width of building accesses shall not be less than 150 cm³⁹.

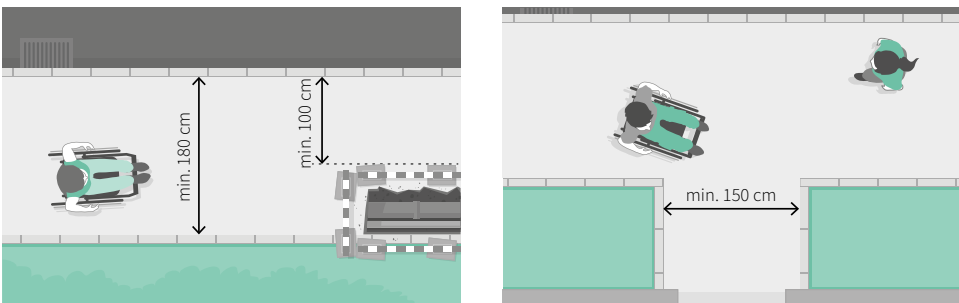

On the left, the width of the pavement on the public road. On the right the width of the pavement leading to the building.

³⁸ Regulation of the Minister of Infrastructure on technical and construction regulations for public roads, § 29.1 and 2.

³⁹ Regulation of the Minister of Infrastructure on the technical conditions to be met by buildings and their location, § 16.1.

Regardless of the requirements set out in the regulations, the minimum needs of wheelchair users must be borne in mind. A width of 150 cm allows a wheelchair user and a walker to pass each other and turn the wheelchair around, 180 cm for two wheelchair users to pass each other (see chapter B.1., p. 29).

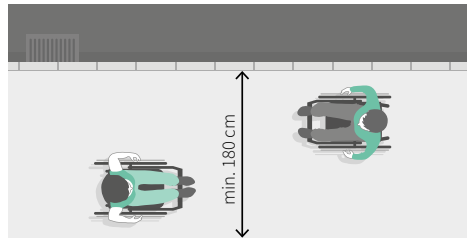
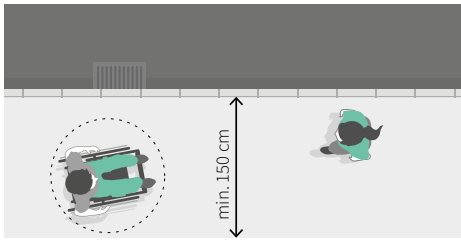

Left – manoeuvring a wheelchair and passing a wheelchair user and an able-bodied person at a pavement width of 150 cm.
Right – two wheelchair users passing each other with a pavement width of 180 cm.

Minimum pavement widths should be calculated after taking into account existing obstacles, e.g. poles, benches, appliances and other equipment.

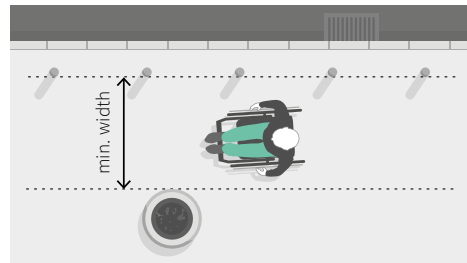
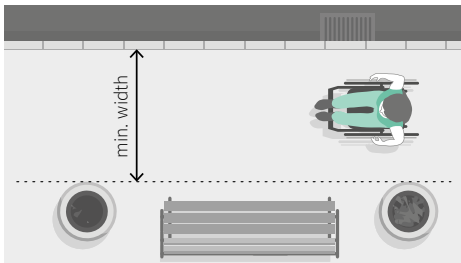

Method of measuring the width of the pedestrian circulation space.

When designing the width of the circulation space, the needs of visually impaired people, for whom too much width means difficult orientation, must not be forgotten (see chapter 1.2, p. 86)..

LOCATION OF SMALL ARCHITECTURE AND EQUIPMENT

Small architecture and other outdoor furnishings should be positioned in such a way that they do not impede the movement of people with mobility impairments and the blind and partially sighted.

It is appropriate to draw a line on the traffic route, which will be the boundary of the location of small architecture and other equipment.

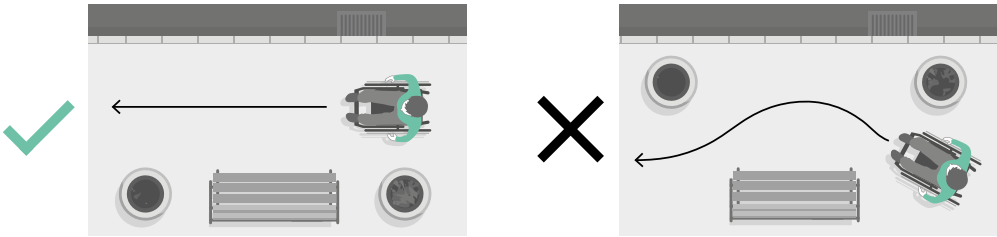

Correct and incorrect positioning of small architecture on pedestrian routes.

If small architecture, such as benches, is placed in the middle of the circulation space, the distances between them should allow passage to the other side of the circulation route.

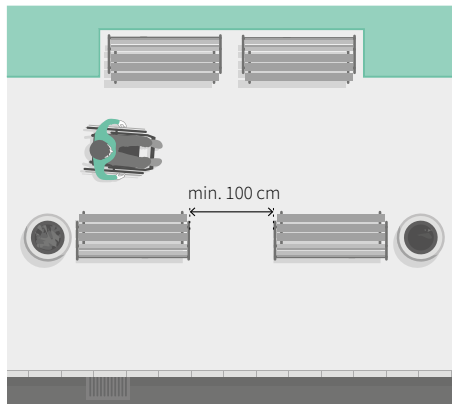

Minimum width of transition between small architectural elements.

2.2. Height of circulation spaces

MINIMUM HEIGHT

The minimum height of pedestrian routes is regulated by law. This height should not be less than 250 cm. Its limitation to 220 cm is only possible by traffic lights, certain road signs and other elements in the course of renovations⁴⁰.

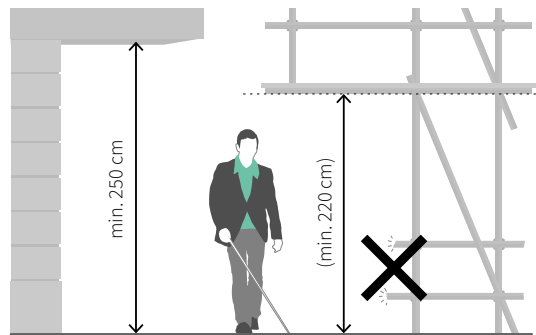

Minimum space height – 250 cm with the possibility of reducing it to 220 cm (pavement repairs, traffic lights, some road signs).

The height of the pavement verge must not be restricted by, among other things, architectural elements, advertisements and information, fixtures and fittings. It is also important to ensure that tree and shrub branches are properly trimmed.

There must be no sharp or protruding parts up to a height of 220 cm. This rule also applies to fences.

People with visual impairments often get around using a white cane or the assistance of an assistance dog. In both cases, only low-lying obstacles can be detected. Therefore, when designing an outdoor space, it is important to take into account the appropriate layout of architectural elements (e.g. poles leaning towards the pavement), fittings, information, advertising, etc.

See chapter B.1 (p. 33) for details..

⁴⁰ Regulation of the Minister of Infrastructure on technical and construction regulations for public roads, § 80.1; Regulation of the Minister of Infrastructure on technical conditions for road signs and signals and road traffic safety devices and conditions for their placement on roads. Annex 1, para. 1.5.3.

2.3. Overcoming differences in levels

For people with limited mobility, horizontal circulation spaces are the most convenient, but often the terrain does not allow height differences to be completely avoided.

Both an increase in inclination and an increase in height difference increase the difficulty of overcoming a change in level. Unless we have a say in how the height difference is designed, the slope should be reduced as the height increases.

With large height differences, the construction of the ramp will require a great deal of space, e.g. with a height difference of 150 cm and a slope of 5%, the length of the ramp will be as long as 30 m, not counting the length of the landings.

It is difficult to clearly define the limit above which a ramp is preferable to a passenger lift. This decision will be influenced not only by the capabilities of the users, but also by the space available, as well as by a cost analysis of the alternatives.

MINOR HEIGHT DIFFERENCES

For small differences in height, it makes sense to design both a staircase and a ramp or gently sloping walkway. For slopes of less than 6% (recommended less than 5%) it is possible to use only the ramp, without stairs.

SIGNIFICANT HEIGHT DIFFERENCES

With large differences in height, the length of the ramp increases significantly. Too great a difference in height, even with a slight incline, can be an insurmountable obstacle for some people. In such a situation, from the users' point of view, it will be more advantageous to provide technical facilities and stairs.

If overcoming the difference in level requires the use of technical equipment, it is a good idea to provide an alternative route in case of emergency, e.g.:

- one entrance is accessible by a ramp or gently sloping walkway and the other by a personnel lift,
- there are two routes to one entrance: a shorter one with a lift and a longer one with a ramp or gently sloping walkway.

2.4. Surfaces

The type of surface and its condition has a significant impact on the comfort and mobility of different groups of people. The parameters of the materials used are particularly important for people with mobility impairments, the elderly, the blind and visually impaired, people with balance disorders and even women wearing heeled shoes.

The assessment of the pavement depends on several factors: the type and treatment of the material, the size of the elements, the size and execution of the gaps between the elements.

TYPE AND METHOD OF MATERIAL PROCESSING

Sandy and uneven surfaces – severely hampering or preventing movement.

Examples of surfaces: sand, gravel, concrete trusses, cobblestones, granite blocks with split surface.

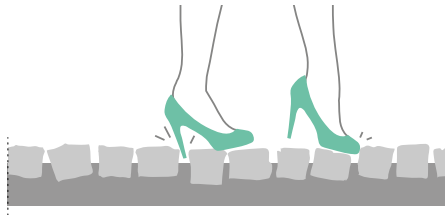

Surfaces with a medium degree of smoothness – obstructive, e.g. surfaces of hammered stone or with irregular edges.

Examples of surfaces: stone with cut surface and split side edges, concrete blocks with irregular side edges.

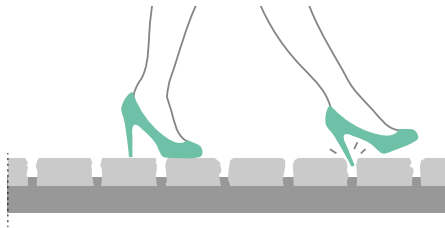

Smooth surfaces – comfortable to move around.

Pavement examples: asphalt, stone slabs with cut, pebbled and radiused surfaces and edges, concrete slabs, planks (subject to adequate weather/warping protection and minimum spacing between planks).

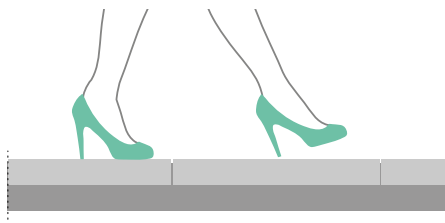

SIZE OF ELEMENTS

The larger the elements, the more comfortable the surface is.

The discomfort resulting from the high frequency of joints (e.g. concrete or granite paving blocks) can be somewhat reduced by using ungrouted elements and taking care with the quality of workmanship and maintenance of the surface in good condition.

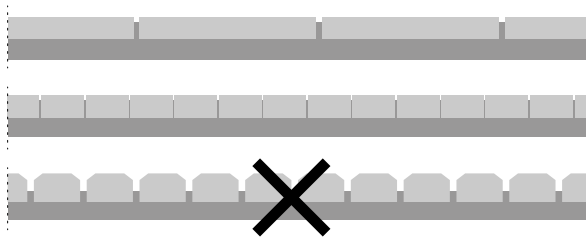

Cross-section through different types of surfaces.

GAPS BETWEEN ELEMENTS AND THE METHOD OF EDGE PROCESSING

The smaller the distances between the elements, the easier it is for people with reduced mobility to move around – joints that are too wide can create a tripping hazard. At the same time, the use of slightly wider joints, with sparse subdivision, does not significantly impair the usability of the surface.

The use of very narrow joints and materials with regular edges without chamfering or rounding significantly increases the usability of pavements made of small elements, such as cut granite blocks or concrete cubes.

Difficulties include large chamfers or curves, as well as irregular edge processing of the material, e.g. a concrete block with a cut surface but split side edges.

When boards are used, the direction of the boards is also important. Longitudinal splits can change the direction of travel of the wheelchair in a manner similar to ruts in the road. The solution may be to lay the boards across the walkway or to significantly reduce the width of the gaps between them.

PRINCIPLES OF USING DIFFERENT TYPES OF SURFACE

Surfaces of pedestrian spaces must be made of smooth materials, with possibly sparse divisions.

Uneven surfacing can be used in side areas of the pavement, e.g. along the edge of the carriageway, the wall of a building, to separate cycle paths from the pavement, to highlight important traffic directions. However, it is necessary to maintain strips of level pavement of the width necessary for the movement of users (see chapter B.1, p. 22).

In squares and wide spaces, it is a good idea to vary the surface by using materials with different textures to mark the main directions of movement. This will make it easier for visually impaired people to get around. This can be achieved by using split tiles, cobblestones, larger or denser joints..

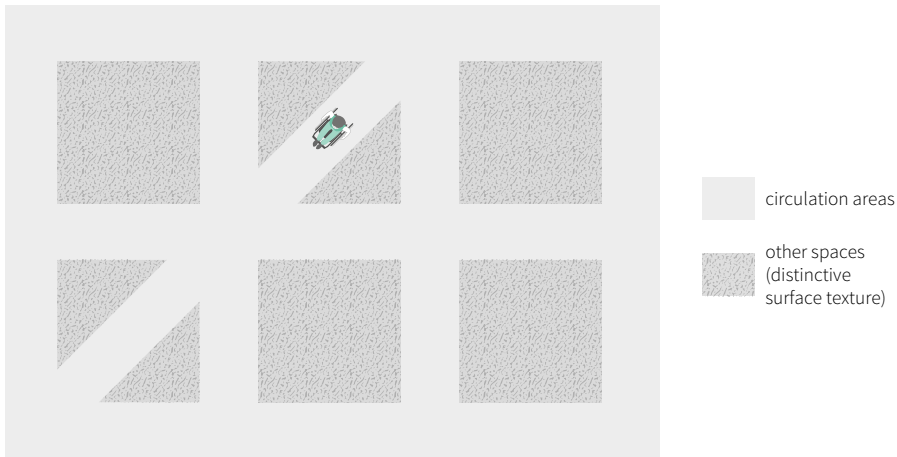

The principle of varying surface types in a way that provides comfort for different user groups.

Main routes with higher pavement standards should be planned in such a way that people with reduced mobility are not forced to travel significantly longer distances than other users.

Changes in surface texture should be designed to emphasise the layout of significant directions. They must not intersect circulation spaces or be randomly placed within them. It is also permissible to supplement the paving around manholes and street gullies, floor-mounted lighting, etc. with cubes or slabs of smaller dimensions than the basic paving. The material used and the way it is processed must be compatible with the surrounding pavement in this situation. Incorrectly designed changes in surface textures may mislead visually impaired people.

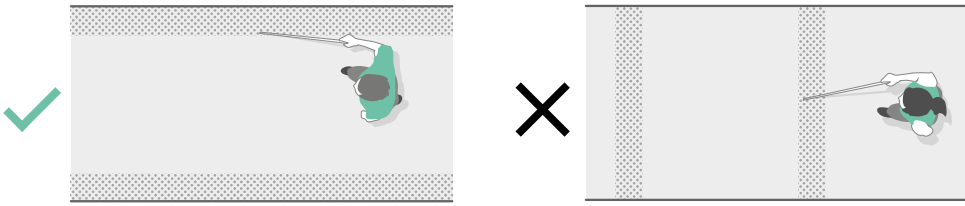

Design principle for pavements made of uneven materials. On the left, uneven paving designed along the edge of the pedestrian route, emphasising the main direction of communication. Right – uneven pavement placed across the pedestrian route.

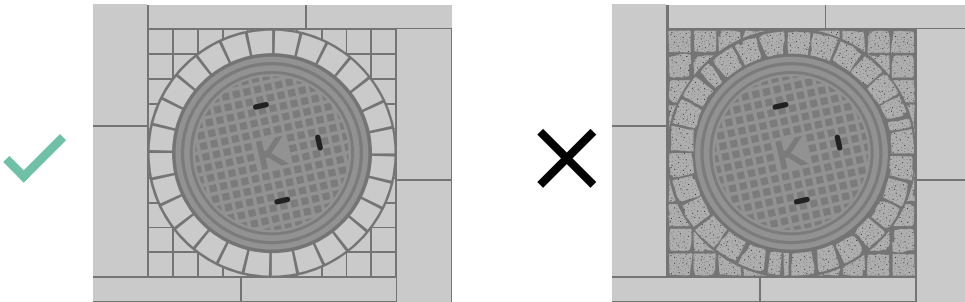

Principle of pavement design around street gullies, manhole covers etc. On the left, reduction in the size of the elements while maintaining the type of material. On the right, a change in material that makes orientation difficult for people with visual impairments.

In the side spaces of the pavement used for lanterns, poles, etc., it is permissible to locate essential elements for users, e.g. benches, kiosks, litter bins, parking vending machines. However, such facilities must be close to the edge of this area so that they can be used by people with reduced mobility.

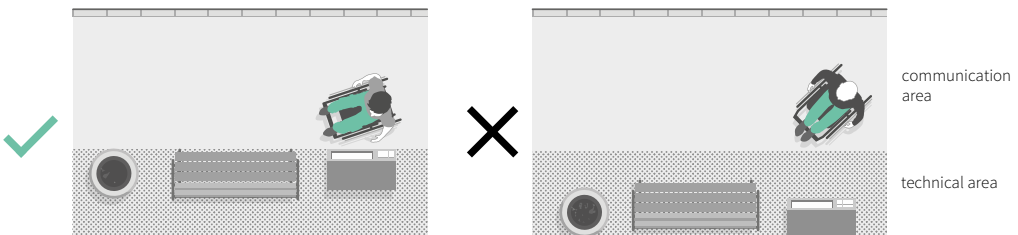

Principle of placement of small architecture and equipment in relation to the types of surface used.

If a roadway, access road, etc. crosses a traffic route, its surface at the intersection must be smooth. However, variations in colour or size of the elements may be considered acceptable.

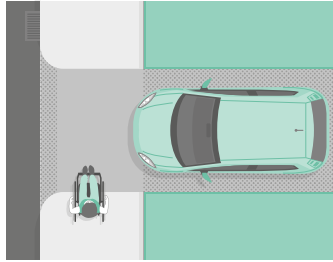

Crossing of access road with uneven surface. Level pavement maintained at the intersection of the pedestrian walkway and the access road.

COVERS FOR MANHOLES, DRAINS ETC.

Covers for manholes and street gullies located on pedestrian routes must have bar spacing or hole diameters of no more than 2 cm⁴¹. At greater distances, there is a risk of locking the wheel of the wheelchair or tripping.

Longitudinal openings should be located across the main direction of traffic.

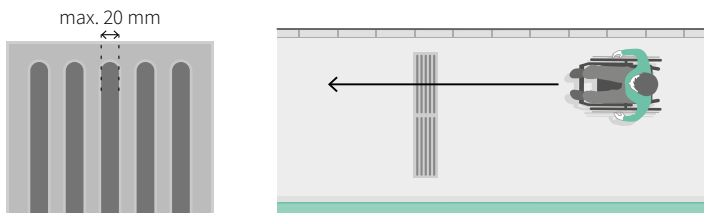

Location and position of drain covers, gullies, revision covers, etc. Prepared on the basis of ADA. Standards for Accessible Design and Polish regulations.

TRANSVERSE INCLINATION

The transverse inclination of pedestrian routes must not exceed 2% and only in difficult situations it may be increased to 3%⁴². See chapters B.2 (p. 35), B.3 (p. 36) and 2.3 (p. 96) for more information.

SURFACE COLOURS

The colour scheme of the surface should be consistent and should emphasise the traffic directions and functions of the individual spaces.

⁴¹ Regulation of the Minister for Infrastructure on the technical conditions to be met by buildings and their location, § 294(2)

⁴² Regulation of the Minister of Infrastructure on technical and construction regulations for public roads, § 33.

2.5. Small architecture

If benches or other types of seating are used on the premises, some of them should meet at least basic ergonomic criteria

- seat height: 40-45 cm,
- seat depth: 40-45 cm,
- height of the upper edge of the backrest from the ground: 75-89 cm,
- height of armrests from the seat: 22-30 cm,
- inclination of the backrest in relation to the seat: 100-105°,
- free space under the seat to allow the feet to step back to change the centre of gravity when standing up⁴³.

Other landscaping elements should be designed in accordance with the parameters set out in chapters A (p. 16) and B (p. 29).

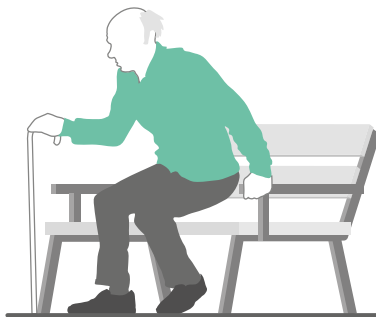

Bench with backrest and armrests to make it easier to use for, among others, the elderly and those with mobility impairments.

2.6. Pedestrian crossings

From the point of view of wheelchair users, parents with prams, people with luggage and also suppliers, it is important to profile the edges of pedestrian crossings appropriately. The following solutions are possible:

- curb ramps – mainly used for crossings of public roadways,
- pedestrian crossing on a speed bump – used where it is important to slow down car traffic and emphasise pedestrian priority,
- positioning of road and pavement on one level – used in areas where car traffic is scarce and pedestrians have absolute priority.

⁴³ ISO 21542:2021, section 9.3.2.

A properly constructed curb ramp should have the following parameters:

- width equal to the width of the crossing⁴⁴;
- inclination perpendicular to the road max. 5% – in exceptional situations an increase of the inclination up to 15% is permissible (a too low inclination will be disadvantageous for visually impaired people, because even if tactile markings are used it may be difficult for them to locate the edge of the road);
- side inclination max. 10% – in exceptional situations an increase of the side inclination up to 15% is permissible;
- the difference in height between the edge of the ramp and the road surface shall be as shown in the illustration below.

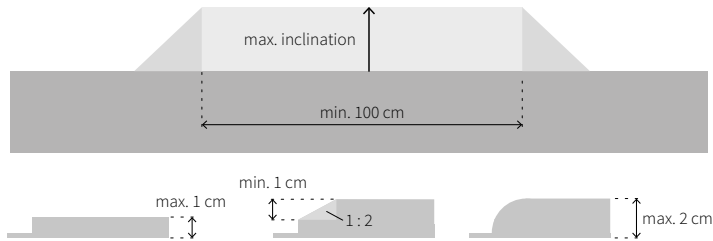

Curb ramp parameters. Prepared on the basis of ADA. Standards for Accessible Design.

A properly constructed crossing located on a speed bump should have the following parameters:

- there shall be no difference in height between the pavement and the level of the crossing at the speed bump;
- there shall be no incline at the border between the speed bump and the pavement, other than that resulting from the incline of the walking route;
- the width of the crossing must comply with the regulations in force, but must not be less than 250 cm.

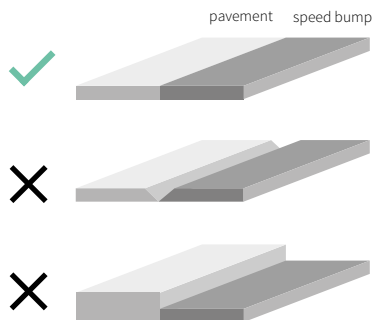

Design principle for the boundary of a pavement with a speed bump where a crossing has been placed.

⁴⁴ Regulation of the Minister of Infrastructure on technical and construction regulations for roads, § 36(2).

In the vicinity of pedestrian crossings, visually impaired people need information about approaching the roadway. The incline of a curb ramp alone is insufficient. It is therefore necessary to provide tactile warning signs. These are usually made in the form of convex domes or truncated cones. Markings of this type are even more important in the case of crossings placed on speed bumps, where a change in inclination does not provide additional warning.

When choosing marking parameters, it is first worth checking which standard applies in a given city. These can vary considerably, e.g. in Łódź, markings consisting of parallel lines are used instead of points.

If there is no local standard, the parameters defined in ISO 23599:2019 can be referred to.

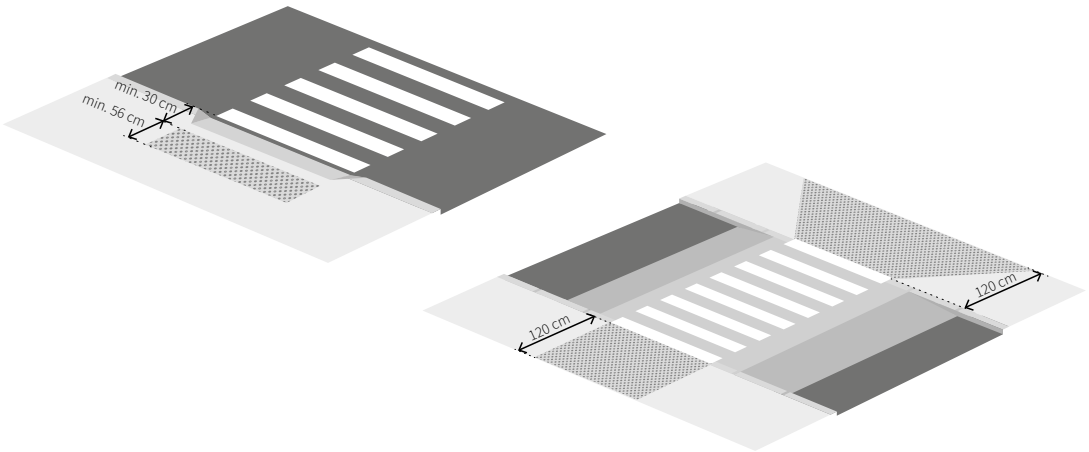

Designing tactile markings at pedestrian crossings. Prepared on the basis of ISO 23599:2019.

2.7. Cycle routes (paths)

Since the speed of pedestrians and cyclists differs significantly, it is necessary to introduce solutions enhancing safety when designing cycle routes. First of all it is necessary to avoid collision points, e.g. the crossing of pedestrian and cycle routes, as well as places, where pedestrians are forced or 'encouraged' to use the cycling route.

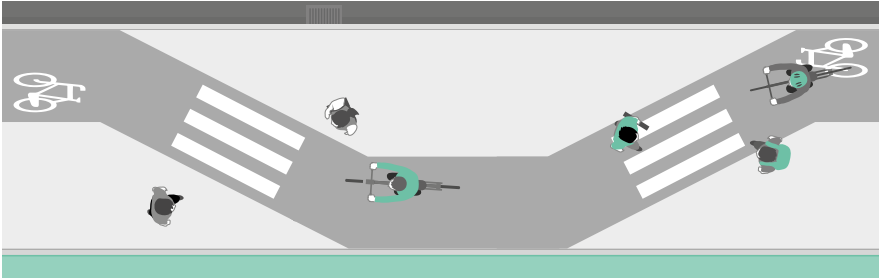

The route repeatedly crosses the pedestrian pathway.

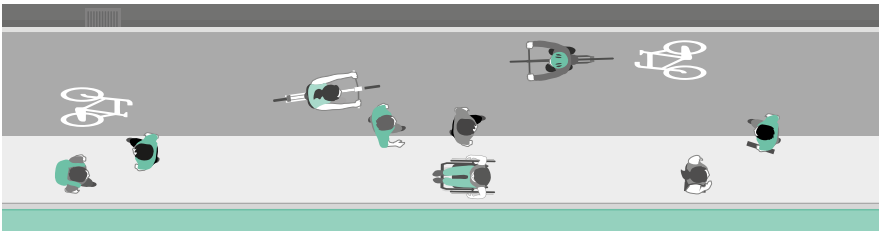

Pedestrian path too narrow for the volume of pedestrian traffic – pedestrians step onto the cycle route.

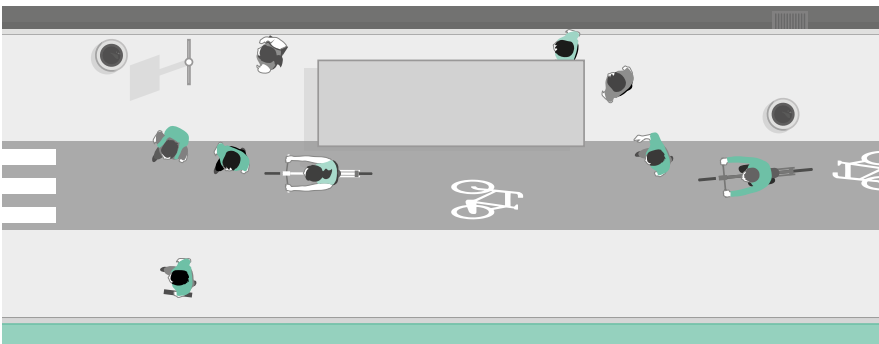

Cycle route directly behind the bus shelter – pedestrians, getting off the bus or wanting to avoid the crowd standing at the bus stop, enter the cycle route.

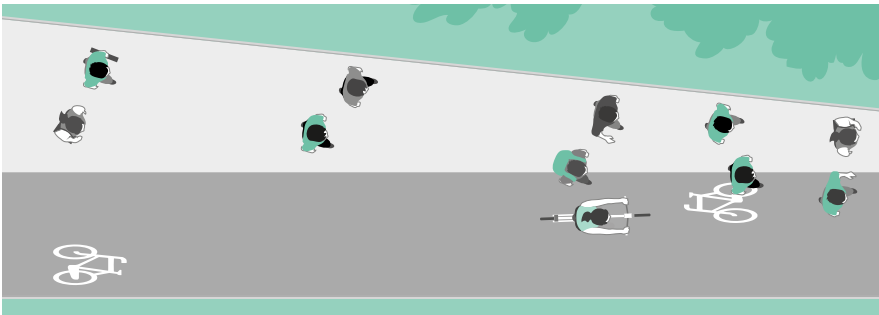

Wedge-shaped pavement – pedestrians are pushed onto the cycle route.

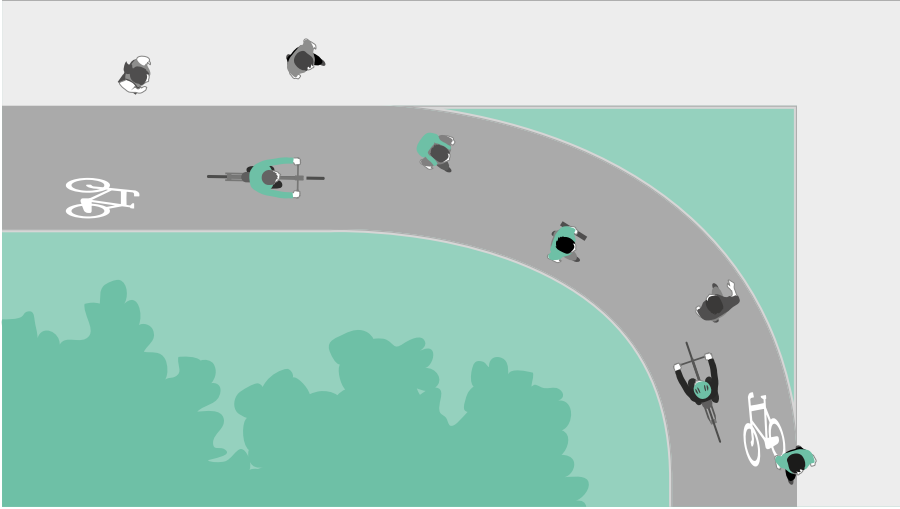

Cycle path taking a shorter route than the pavement – pedestrians cutting corners.

The cycle route should be marked with horizontal signs. An additional solution, beneficial e.g. for visually impaired people, is to differentiate the cycle route and the pavement by colour.

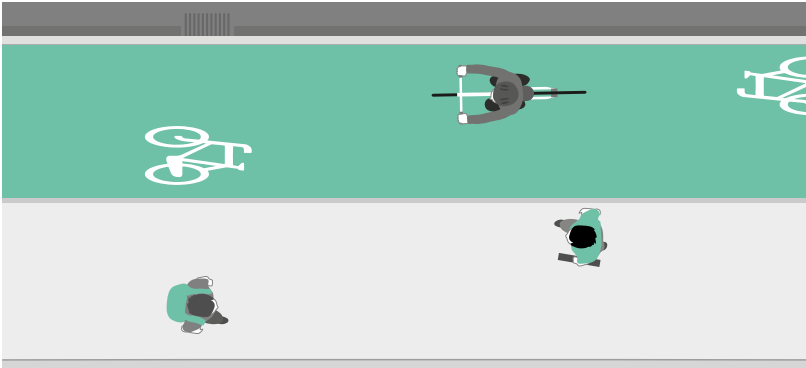

Cycle route in a different colour to the pavement. A solution beneficial for visually impaired people, among others.

For the visually impaired, solutions are needed to enable path detection with a white cane. It is possible, for example.:

- separating it with a green strip – the most beneficial solution, causing the separation of pedestrian and cyclist traffic;
- change of texture – it is possible to use, for example, a strip of granite blocks with a split surface. The width of such a strip must not be less than 30 cm;
- raising the surface (hump between the path and the pavement). Preferably combined with a change in texture.

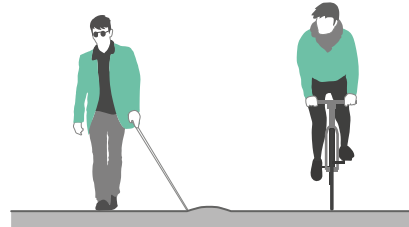
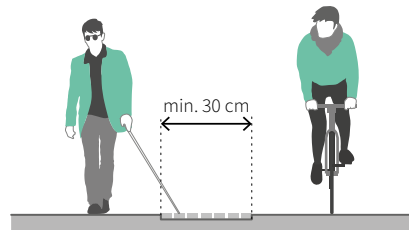
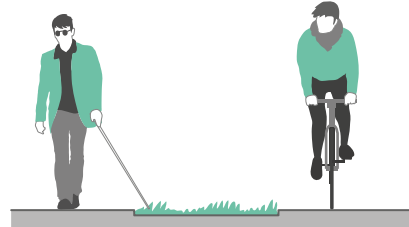

Markings must be made in such a way that where cycle routes intersect with pavements they do not create an obstacle for people with reduced mobility.

Detailed requirements for the design of cycle routes can be found in local standards prepared by municipal authorities.

IMPORTANT PARAMETERS

WIDTH OF PAVEMENT AND HEIGHT OF SPACE ABOVE PAVEMENT

Width on public road: min. 180 cm.

Width at building access: min. 150 cm (recommended min. 180 cm).

Excessively wide pavement is disadvantageous for visually impaired people due to impaired orientation in space.

Min. height: 250 cm.

Permissible reduction in height to 220 cm by traffic lights, some signs and in the case of renovations.

PASSING PLACES (TWO WHEELCHAIR USERS PASSING EACH OTHER)

Necessary when circulation width is less than 180 cm.

Distances between passing places: max. 25 m.

Passing space length: min. 200 cm.

Passing space width: min. 180 cm.

HEIGHT DIFFERENCES

Design principle for level changes:

- slight height differences: pavement with a incline of less than 6% (less than 5% recommended) or stairs and ramp,
- large height differences: stairs and technical equipment.

Decision-making process when selecting technical equipment (from most favourable to least favourable):

passenger lift



vertical lift

rather in existing buildings



stairlift

only in existing buildings
(exceptional situations)

SURFACES

Types of materials (from least to most favourable):

- sandy and uneven surfaces, e.g. sand, gravel, concrete trusses, cobblestones,
- with a medium degree of evenness, e.g. stone with cut surfaces and split edges, concrete blocks with uneven edges,
- even, e.g. asphalt, cut stone, stone or concrete slabs.

Other factors influencing surface comfort:

- size of elements: the larger the elements, the more favourable,
- gaps between elements: the smaller the better,

- edge treatment: it is recommended to use materials with straight edges, without chamfering or rounding.

Main traffic routes: even surfaces, large elements with minimal gaps between them are recommended.

Covers for manholes, drains, etc.: Gaps between elements/bore diameters: max. 20 cm; arrangement of elements: transverse to main direction of traffic.

TRANSVERSE INCLINATION OF THE PAVEMENT

Incline at maximum: 2%

In difficult situations an increase up to 3% is permissible.

SEATS

At least some of the benches meeting the basic ergonomic criteria according to section 2.5 (p. 102).

PEDESTRIAN CROSSINGS

Design of crossings:

- curb ramps – crossings of main roads,
- crossings on speed bumps – where pedestrian priority needs to be emphasised,
- road and pavement at the same level – areas with absolute priority for pedestrians and occasional car traffic.

CURB RAMPS

Width equal to width of crossing, incline max. 5% (in exceptional situations up to 15%). Height difference between ramp edge and the road max. 1 cm or max. 2 cm with suitable edge profiling.

TACTILE MARKINGS

Place of use: at least at public road crossings.

Parameters: according to local standards or ISO 23599:2019.

CYCLE ROUTES (PATHS)

Separation of cycle routes from the pavement:

- best solution: separation by a green strip,
- other solutions: border made of uneven pavement, raised pavement on the border (hump).





3 | CAR PARKS AND GARAGES

3 | CAR PARKS AND GARAGES

3.1. Location of parking places

Parking places for people with disabilities should be close to the building entrance or circulation path. If the car park is away from the building, these places should be designed close to the exit of that car park.

Floors with parking places for persons with disabilities must be accessible from ground level by means of a lift or ramp.

Places for people with disabilities can be close to the windows of buildings without any restrictions⁴⁵.

3.2. Number of parking places for people with disabilities

The minimum number of parking places for persons with disabilities is specified in the Public Roads Act. It should be in accordance with the table below⁴⁶.

Number of parking places for people with disabilities in relation to the total number of places

Total number of places	Minimum number of places for people with disabilities
6-15	1
16-40	2
41-100	3
over 100	4% of total number of places

⁴⁵ Regulation of the Minister of Infrastructure on the technical conditions to be met by buildings and their location, § 20.

⁴⁶ Public Roads Act, Article 12a.

These regulations apply on public roads and in residential and traffic zones. In other situations, the number of parking places for people with disabilities should be based on local development plans or development conditions issued for the development. It is, however, advisable that it is not less than that indicated in the table.

3.3. Parameters of parking places

The dimensions of the places should be in accordance with the table below⁴⁷.

Dimensions of parking places for people with disabilities

	Perpendicular and diagonal parking	Parallel parking
Width	360 cm	360 cm
Length	500 cm	600 cm

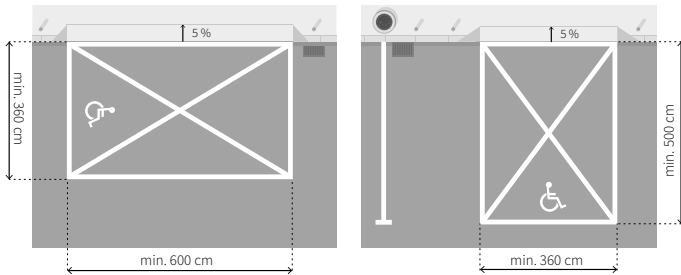

Dimensions of parking places for people with disabilities. Parallel parking on the left, perpendicular parking on the right.

Regardless of the location of the place and its dimensions, it is necessary to ensure that it is possible to access the pavement or footway directly from the parking place or its immediate vicinity. It is unacceptable that a person in a wheelchair is not able to access the pavement and is forced to move on the road, e.g. due to a high curb, placed flower pots or installed posts.

⁴⁷ Regulation of the Minister of Infrastructure on the technical conditions to be met by buildings and their location, § 21(1)..

3.4. Parking place marking

The method of marking depends on the location of the place, as shown in the table below.

Principles of marking parking places

	Public roads	Other roads
Vertical and horizontal signs	Horizontal sign P-18 with symbol P-24, in combination with vertical sign D-18 and plate T-29 or horizontal sign P-20 with symbol P-24, combined with vertical sign D-18a and T-29 label ⁴⁸	Other legible signage acceptable, e.g. in accordance with the building's visual information system
Surface colour of the place	Blue	Recommended colour highlighting

Finding parking places and using them can be made easier by:

- placing information near the entrance to the car park about the location of parking places for people with disabilities,
- use of a lighting system to indicate vacant and occupied places – places for people with disabilities may be marked with a different colour of light, e.g. blue,
- the provision of information indicating the way to circulation paths/entrances to the building. If not all of these are accessible to wheelchair users, it is necessary to indicate which have been adapted accordingly.

⁴⁸ Ordinance of the Minister of Infrastructure on the technical conditions for road signs and signals and road traffic safety devices and the conditions for their placement on roads, Annex 1, para 5.2.18; Annex 2, paragraphs 5.2.4 and 5.2.6.

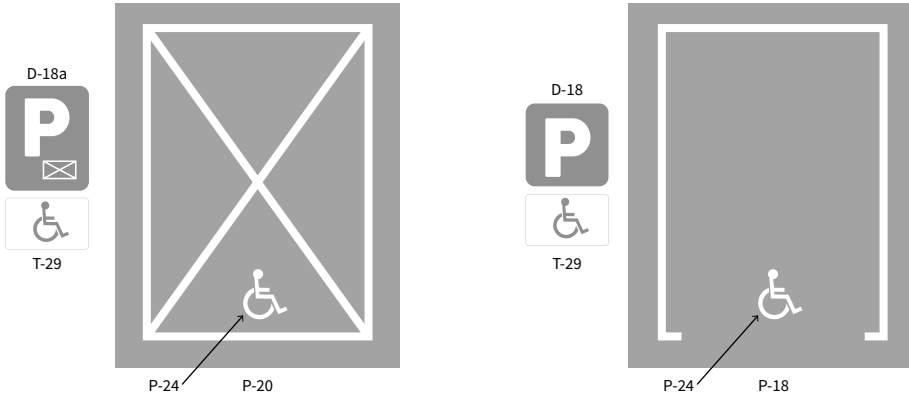

Marking of parking places.

3.5. Parking vending machines

If parking vending machines are installed, care should be taken to ensure that they are accessible to wheelchair users and those of low height.

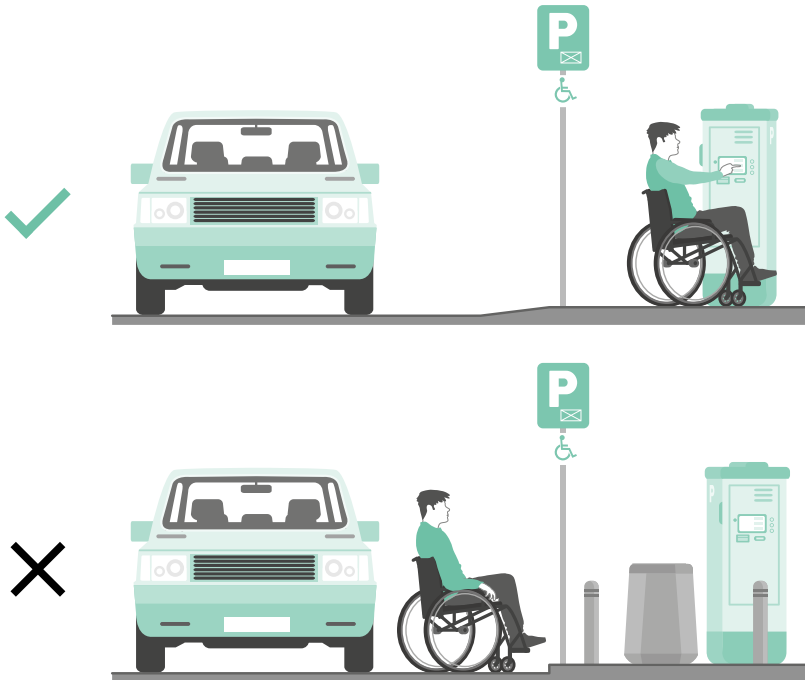

Providing access to the parking meter. Top situation correct, bottom access is impeded by high curb and other obstructions.

It is possible to design all vending machines as universally accessible or to place different machines next to each other – at least one adapted to the height of able-bodied persons and another one for wheelchair users and those with low height.

In a vending machine accessible to persons with disabilities, all buttons, pockets and the touch screen (if present) must be at a height of 80-110 cm (the screen without the touch function may be higher).

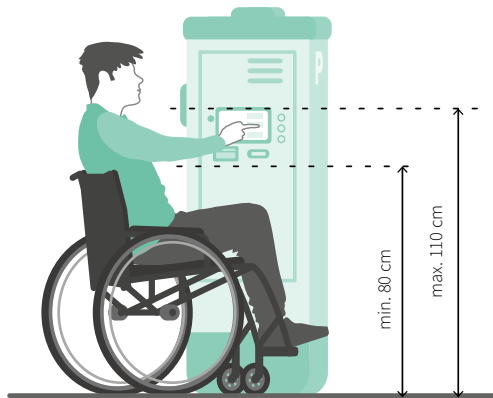

Height ranges for the placement of essential elements of the machine to ensure access for different groups of people.

If the vending machine is to be accessible to both able-bodied and wheelchair users, it will be beneficial to tilt the screen in such a way as to ensure optimal readability for the different user groups (their gaze may be at different levels). It will also be important to ensure that the screen matrix has the widest possible readability angle.

3.6. Management of places for people with disabilities

In office buildings, it is recommended to reserve at least part of the parking places for people with disabilities in the general pool of places in order to:

- provide a place to visitors with disabilities,
- make it possible to convert a normal parking place into a place for a person with a disability, e.g. in the event of hiring a new employee who needs such a place.

IMPORTANT PARAMETERS

LOCATION OF PARKING PLACES FOR PEOPLE WITH DISABILITIES

Outdoor car parks: as close as possible to the entrance of the building or, in the case of car parks away from the building, close to the exit of the car park.

Garages in the building: as close as possible to the entrances to the circulation paths. All garage floors must be accessible to persons with reduced mobility.

NUMBER OF PARKING PLACES FOR PEOPLE WITH DISABILITIES

On public roads, in traffic zones and residential zones:

Total number of places 6-15: 1 place.

Total number of places 16-40: 2 places.

Total number of places 41-100: 3 places.

Total number of places > 100: min. 4% of the total number of places.

On other roads in accordance with the local development plan or development conditions. Recommended in accordance with the regulations for public roads.

PARAMETERS FOR PLACES FOR PEOPLE WITH DISABILITIES

Perpendicular or diagonal parking:

- width: min. 360 cm,
- length: min. 500 cm.

Parallel parking:

- width: min. 360 cm,
- length: min. 600 cm.

MARKING OF PARKING PLACES FOR PEOPLE WITH DISABILITIES

Possible sign sets:

- variant 1: Horizontal sign P-18 with symbol P-24 and vertical sign D-18 with label T-29,
- variant 2: Horizontal sign P-20 with symbol P-24 and vertical sign D-18a with label T-29.

Surface colour of the place: blue.

In a building where it is not necessary to apply the public highway regulations, other place markings may be possible, e.g. in accordance with the building's visual identity system.

Display of additional information for car park users:

- at the entrance to the car park – information on the location of parking places for people with disabilities,
- in a car park or garage – luminous information indicating vacant and occupied parking places and, by means of another colour (e.g. blue), the location of spaces for people with disabilities,
- in a garage – visual information showing the way to the circulation paths. If not all paths are accessible to persons with reduced mobility, there shall also be information pointing the way to accessible paths.

PARKING VENDING MACHINES

Number of wheelchair accessible vending machines: at least one per vending unit.

Position height of buttons, pockets, touchscreen (if any): 80-110 cm.

Position of regular screen: acceptable above 110 cm, recommended to place screen at an angle.

Screen matrix: large readability angle necessary.

MANAGEMENT OF PLACES

When parking places are rented, it is advisable to leave places for people with disabilities in the pool of public places, for the use of visitors or employees.





4 | ENTRANCES

4 | ENTRANCES

4.1. Location of entrances

The location of entrances and the number of entrances depends on the location and size of the building, its relationship to significant pedestrian routes, and the terrain. It is most advantageous for building users to provide entrances from any side from which significant pedestrian traffic can be expected, e.g. from public transport stops, major intersections, car parks.

However, the terrain does not always allow for equal access to all entrances. In such a situation, at least the main entrance should be universally accessible. Any other situation is only permissible in existing buildings undergoing reconstruction or in particularly difficult terrain conditions.

If not all entrances to a building are accessible to persons with reduced mobility, it is necessary to provide clear information indicating the appropriate route. Such information should be presented with arrows and the symbol of a person with a disability, and in the case of a very complicated access, it is recommended to present a diagram of the building. More information on information design is presented in chapter B.7 (p. 57).

4.2. Level differences at the entrance

If there are significant changes in levels at the entrance, follow the rules described in chapter 2.3 (p. 96).

If there is an incline of more than 5% directly in front of the entrance door, a horizontal manoeuvring space of at least 150 x 150 cm must be provided. This space must not be restricted by the door opening area. Large inclinations directly in front of the door make it difficult for wheelchair users to open the door.

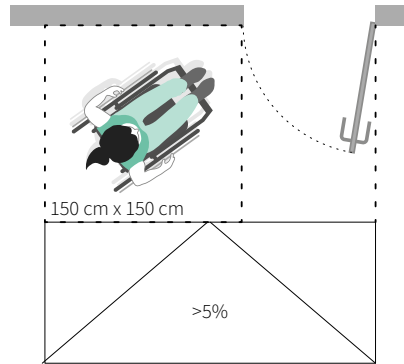

Maneuvering space in front of the front door.

Ramps should be designed in accordance with the information given in chapter B.3 (p. 36).

Stairs should be designed in accordance with the information given in chapter 7 (p. 174).

Passenger lifts and vertical lifts should be designed in accordance with the information given in chapter 6 (p. 142).

4.3. Door types and parameters

The accessibility of the entrance depends on the choice of door type, opening method, width, thresholds, hardware and other parameters.

Detailed information on door selection and design can be found in chapter B.4. (p. 39).

4.4. Vestibules and manoeuvring spaces at doors

The vestibule should have the following parameters:

- width of min. 150 cm,
- length of min. 120 cm, increased by the width of the door leaves opening into the vestibule, but never less than 150 cm. For example, if one door leaf opens into the vestibule with a width of 90 cm, the length of the vestibule must be min. 210 cm⁴⁹.

For particularly important entrances, it is advisable to increase the distance between consecutive doors from 120 to 150 cm⁵⁰.

⁴⁹ ADA. *Standards for Accessible Design*, section 404.2.6.

⁵⁰ ISO 21542:2021, section 6.6.4.

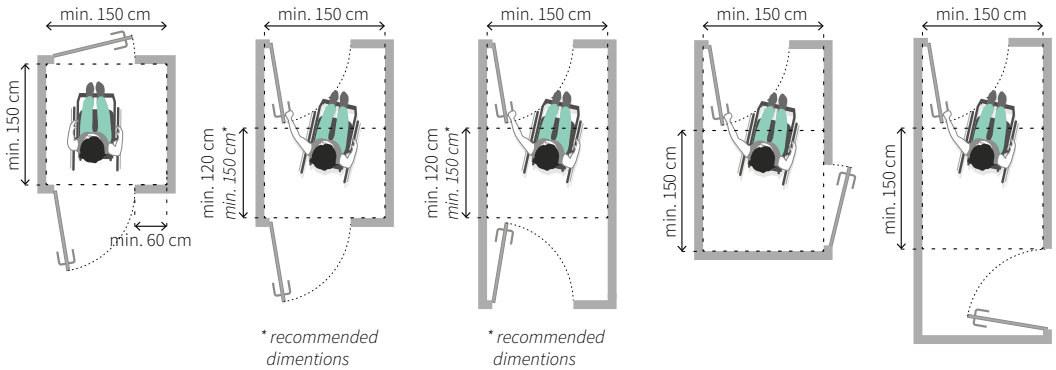

Parameters of the vestibules. Prepared on the basis of ADA. Standards for Accessible Design and ISO 21542:2021⁵¹.

The same principles should be applied in areas inside the building, e.g. in vestibules in front of toilets for people with disabilities.

In the case of manually-operated swing doors, it is necessary to provide manoeuvring space to enable a person in a wheelchair to open the door independently:

- recommended variant – a manoeuvring area at the side of the door, on the handle side, of min. 150 x 150 cm,
- permissible variant – free space of min. 60 cm, at the side of the door, on the handle side.

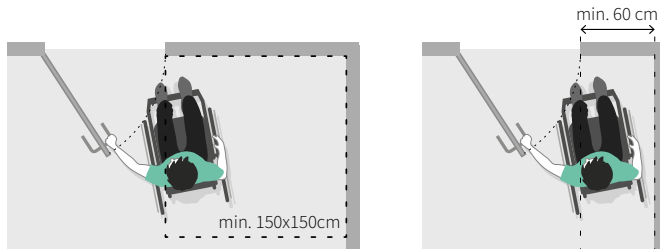

Manoeuvring space in front of the entrance door. On the left, the recommended solution.

For detailed information on the parameters of the manoeuvring space at the door, see chapter B.4. (p. 47).

⁵¹ ISO 21542:2021 requires vestibules of 150 cm + width of wings opening into the vestibule, ADA – 120 cm + width of these wings.

4.5. Partitions and transparent doors

In new buildings, the entrance hall is usually designed as an open, inviting space, so most external walls and doors are glazed. This ensures that the interior is well lit by daylight and intermingles with the outdoor space. However, large glazings can make it difficult to define the distinction between what is inside and outside. In an extreme situation, it is possible for the user to collide with a poorly visible sheet. Large glazings are particularly problematic for visually impaired people.

If more than 75% of the surface of the door or wall is transparent, it is necessary to provide appropriate markings. See chapter B.5 for more information (p. 51).

4.6. Footwear cleaning systems

A well-designed shoe cleaning system keeps the building clean and eliminates the need for additional floor coverings for a significant part of the year. Not all of the available solutions provide adequate comfort and safety for users. The different types of system are described in the table.

Comparison of different types of footwear cleaning systems based on user comfort

Type of system	Advantages	Disadvantages	Additional information
System doormats (mouldings with inserts)	Recessed into the floor, they pose no tripping hazards. They do not roll or slide.	They have a slightly uneven surface which may make wheelchair travel minimally difficult.	Must be recessed into the floor.
Carpets	They are flat. If they don't roll up, they have minimal impact on wheelchair comfort.	There is a risk of tripping. They can shift and roll up. If they are too small, there is a risk of slipping.	For the safety of the users it is recommended that the carpet is additionally fixed to the floor.

Type of system	Advantages	Disadvantages	Additional information
Grates	If they are well designed, they do not affect the ability to move.	A cane or heel can fall between the gaps.	Adequate spacing must be maintained between the grate elements.
Mesh rubber doormat		If they are not recessed into the floor, it can be difficult for a wheelchair user to drive over their edge. The structure of the doormat (large mesh diameter, soft material) seriously impedes mobility.	Their use should be avoided

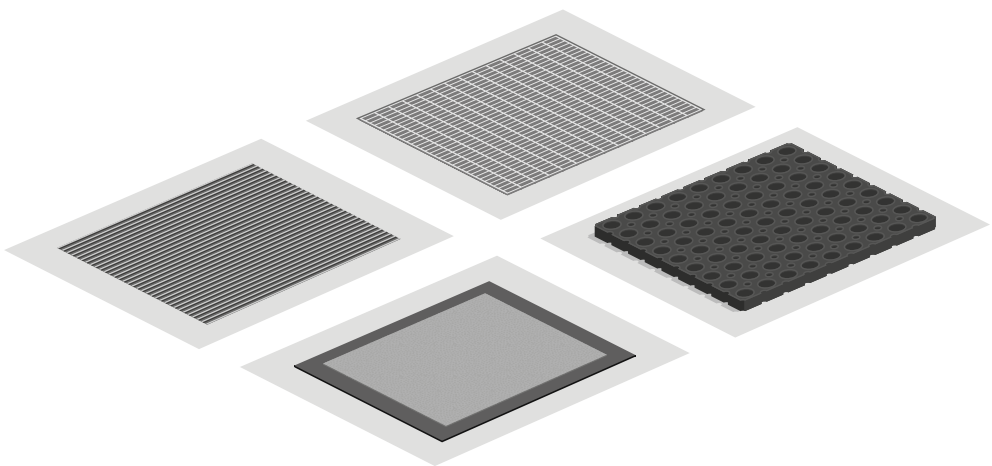

Different types of footwear cleaning systems. Top left: system doormat recessed into the floor and steel grating, bottom carpet and thick rubber doormat.

The most advantageous solution is system doormats, which are recessed into the floor. The carpets can be used during inclement weather to complement the basic system, as well as in small facilities where the use of system doormats may not be economical. However, it should be borne in mind that carpets can present a tripping or slipping hazard. Grates, on the other hand, are unlikely to work well in large facilities due to their low capacity. If it is necessary to use them, the distances between elements or the diameters of the holes must not be greater than 20 mm..

Thick, rubber mesh doormats should definitely be avoided, as they seriously impede movement.

IMPORTANT PARAMETERS

LOCATION OF ENTRANCES

Most favourable: entrances from each significant direction of access to the building.

Most favourable way to ensure accessibility: all entrances accessible from ground level.

Inaccessible entrances: information directing to an adapted entrance must be provided.

LEVEL DIFFERENCES IN FRONT OF THE DOOR

See information given in chapter 2.3 (p. 96).

DOOR PARAMETERS

See information given in chapter B.4 (p. 38).

VESTIBULES AND MANOEUVRING SPACE AT THE DOOR

Vestibule width: min. 150 cm.

Length of vestibule: min. 120 cm (150 cm recommended) + width of wings opening into the room, never less than 150 cm.

Manoeuvring space at the door: recommended min. 150 x 150 cm outside the door opening area and maintain min. 60 cm free space on the handle side. For more information see chapter B.4. (p. 38).

PARTITIONS AND TRANSPARENT DOORS

See information given in chapter B.5 (p. 50).





5 | **LOBBY**

5 | LOBBY

5.1. Circulation system

The lobby is a key element of a building's circulation system. It is here that the traffic of employees and visitors intersects, and the circulation system of the entrance area should enable them to find the right way for their needs. An important element of the lobby is the reception area, which should fulfil the following conditions:

- located in such a way that people standing next to it do not block the passage, e.g. slightly removed from the main circulation space or placed in a wide area,
- located near the entrance and access control gates - in this way it is easy to find and staff can respond to users' difficulties.



Example of circulation system in the building lobby - reception desk near the entrance, clear separation of visitor and employee traffic.

The widths of circulation spaces must be adapted to the expected traffic volume. In addition, the needs of different user groups, in particular wheelchair users, must be taken into account. See chapter B.1 for more information (p. 29).

5.2. Reception desk

RECEPTION DESK PARAMETERS

Placing the reception desk close to the entrance will enable staff to observe and assist people entering the building, and it will be easier for visitors entering the building to find it.

A low countertop at the reception desk makes it easier to establish contact between the receptionist and a wheelchair user or a person with low height. On the other hand, a high countertop ensures the receptionist's comfort by separating them from the movement of people in the building's lobby, and also makes it easier to sign or fill in documents without having to sit down. It is therefore advantageous to design reception desks with two countertop levels: 110-115 cm and up to 90 cm (some standards indicate 80 cm).

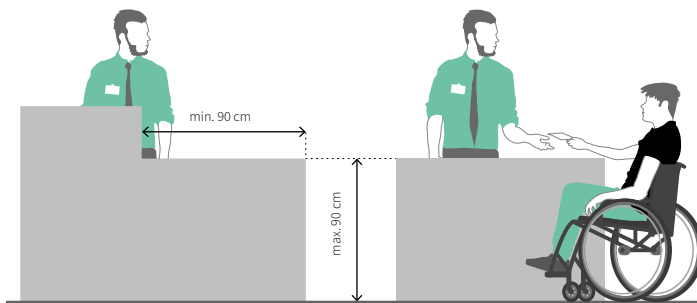

Reception desk parameters.

The lower part of the countertop should be designed at the front, so that the wheelchair user does not feel like an inferior user. It should also not be obstructed by any equipment (e.g. a monitor), information items or advertising.

If documents need to be filled in at the workstation, a clear space of at least 70 cm in height and at least 60 cm in depth must be provided under the countertop⁵².

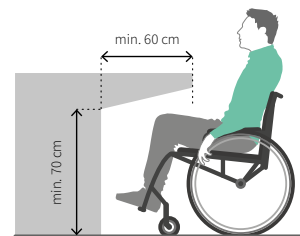

Countertop parameters for comfortable wheelchair access.

⁵² ISO 21542:2021, section 10.1.3.

LIGHTING

For many people, including those with hearing impairments, adequate lighting of the employee's face is important. Light sources placed behind the receptionist's back or positioning the reception desk with the back to the window make it difficult to recognise facial expressions or assist with lip reading.

A similar effect can be produced by point light, which, when falling on the face, causes sharp shadows. The light should be diffused and must illuminate the face evenly.



Different ways to illuminate the face of a receptionist.

SOLUTIONS FOR PEOPLE WITH HEARING IMPAIRMENTS

For the hearing impaired, it is helpful to have an induction loop and an online sign language interpreter installed at reception.

The induction loop is designed for people with impaired hearing. It converts the signal from sound into an electromagnetic signal, which is then picked up by a hearing aid. In this way, only the employee's voice reaches the hearing-impaired person, without unnecessary background noises. The user of the hearing aid needs to know that they should switch their hearing aid to the inductive loop mode, so it is important to mark the position appropriately.



Induction loop symbol.

Ideally, the loop consists of a microphone, an amplifier and a cable stretched under the tabletop. There are also all-in-one loops that can be easily moved between stations. The problem, however, is ensuring that the signal quality is adequate. The loop has to be reconfigured after each repositioning, and employees usually do not have the skills or enough time.

Induction loop will not be helpful for poor hearing people.

The Deaf who use sign language can make use of an online interpreter.

This can be operated, for example, via a tablet or other device, and the receptionist does not then need to know sign language.

As with the induction loop, it is necessary to mark the desk appropriately.

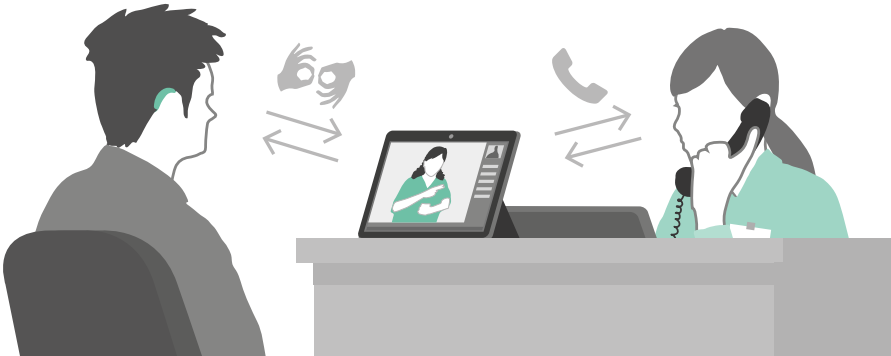

Online sign language interpreter operation diagram.



Sign language interpreter symbol.

5.3. Cloakroom

If a cloakroom is designed in the building, its countertop should be entirely at a height of up to 90 cm or divided into parts of different heights, of which the section with a width of min. 90 cm must be at a height of up to 90 cm.

If the cloakroom is self-service, at least some of the hangers must be at a height of 100-110 cm, i.e. within reach of a person in a wheelchair.

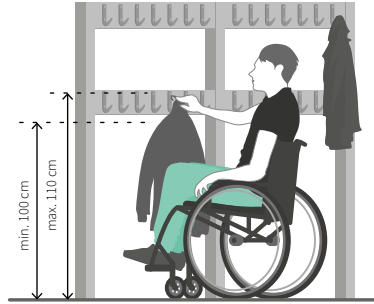

Hangers in the self-service cloakroom at two heights.

5.4. Seating areas

The provision of seats in the lobby is important. Their type and parameters have an impact on the comfort of the people using them.

Furniture with a seat that is too low, without armrests or backrests, can make it difficult to sit down and stand up. A seat that is too high, on the other hand, will put pressure on blood vessels and nerves running under the knee. For this reason, it is important to vary the types of seats and to provide armrests and backrests.

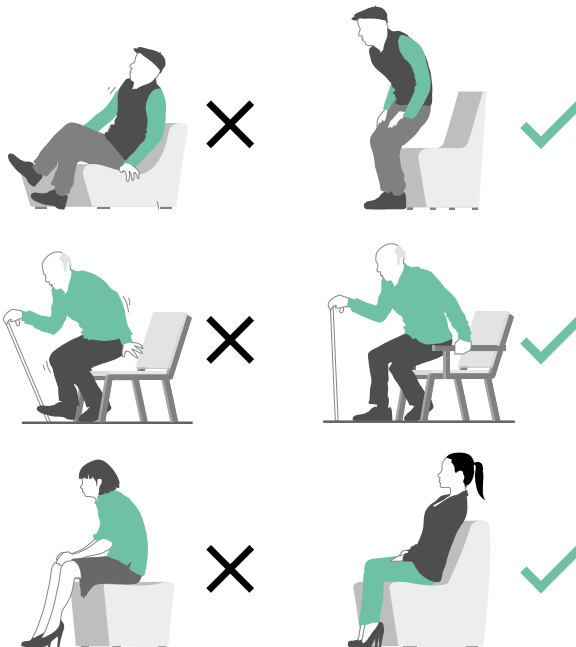

Seat parameters and user comfort.

5.5. Access control gates

At least one access control gate in a unit should be min. 90 cm and allow passage for wheelchair users. The gate must not be fitted with turnstiles.

The wider gate, like the others, should be equipped with an access card reader. For people with upper limb disabilities, readers that operate from a distance and detect a card concealed, e.g. in a jacket pocket, are advantageous.

A manoeuvring space of at least 150 x 150 cm must be provided on both sides in front of the gate..

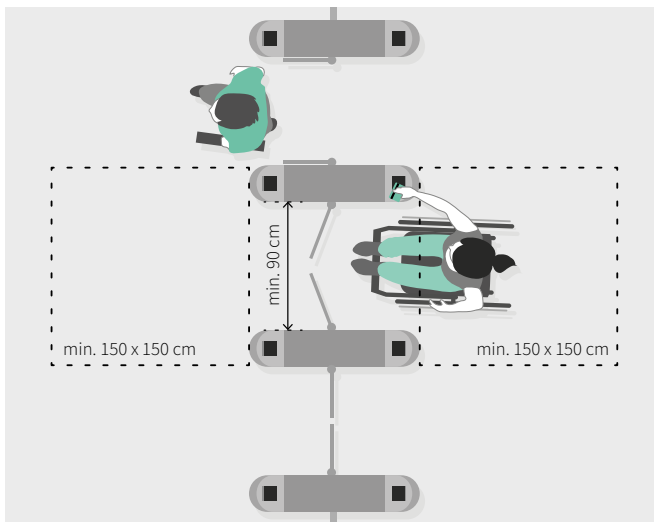

Provision of a wider access control gate for people with reduced mobility.

IMPORTANT PARAMETERS

CIRCULATION SYSTEM

Location of the reception desk:

- in a location that allows separation of staff and visitor traffic,
- close to the entrance,
- close to access control gates.

RECEPTION DESK

Countertop height:

- lower level: max. 90 cm (in some standards max. 80 cm),
- upper level (recommended): 110-115 cm.

Lighting: diffuse, soft, light falling on the receptionist's face at the front, avoiding a strong light source behind the receptionist's back.

Solutions for the poor of hearing: induction loop.

Solutions for the deaf: online sign language interpreter..

CLOAKROOM

Top height: at least a section with a width of min. 90 cm at a height of up to 90 cm.

Position of hangers (self-service): at least part of hangers at a height of 100-110 cm.

SEATS

Different types of seats (e.g. chairs, armchairs, sofas), with varying seat heights, backrests and armrests.

ACCESS CONTROL GATES

Passage width: min. 90 cm (at least one gate per unit; gate must not have a turnstile).

Wider gate without turnstile.

Manoeuvring space: min. 150 x 150 cm on both sides of the wider gate.

Access card readers: provided at all facilities, including the wide gate.

Recommended solutions: readers operating from a distance, without the need to hold a card.





6 | LIFTS

6 | LIFT LOBBIES AND PASSENGER LIFTS

6.1. Size of lift lobbies

The width of circulation spaces must be adapted to the expected traffic volume. In addition, the needs of different user groups, in particular wheelchair users, must be taken into account. For more information, see chapter B.1 (p. 29).

6.2. Lift parameters

LIFT CABIN DIMENSIONS

The regulation on the technical conditions to be met by buildings and their location specifies that the lift cabin intended for a person with a disability must not be smaller than 110 x 140 cm. In practice, its size should also depend on other factors, including the position of the door on the shorter or longer wall of the cabin, the number of doors and their arrangement, the distance of the door from the corner of the lift cabin.

The dimensions of the lift cabin must be no less than:

- 110 x 140 cm – at the door on the shorter side of the cabin (also for pass-through doors),
- 110 x 210 cm – with these dimensions, when the door is on the shorter side, it is possible to transport a person on a stretcher;
- 150 x 150 cm or 140 x 160 cm – cabins where it is necessary to turn the wheelchair, e.g. two pairs of doors located on perpendicular sides of the cabin,
- 130 x 170 cm – with the door located on the long side of the cabin, close to the corner,
- 130 x 200 cm – door placed on the long side of the cabin, in the middle of the wall⁵³.

⁵³ Prepared on the basis of ISO 21542:2021 and ADA. Standards for Accessible Design.

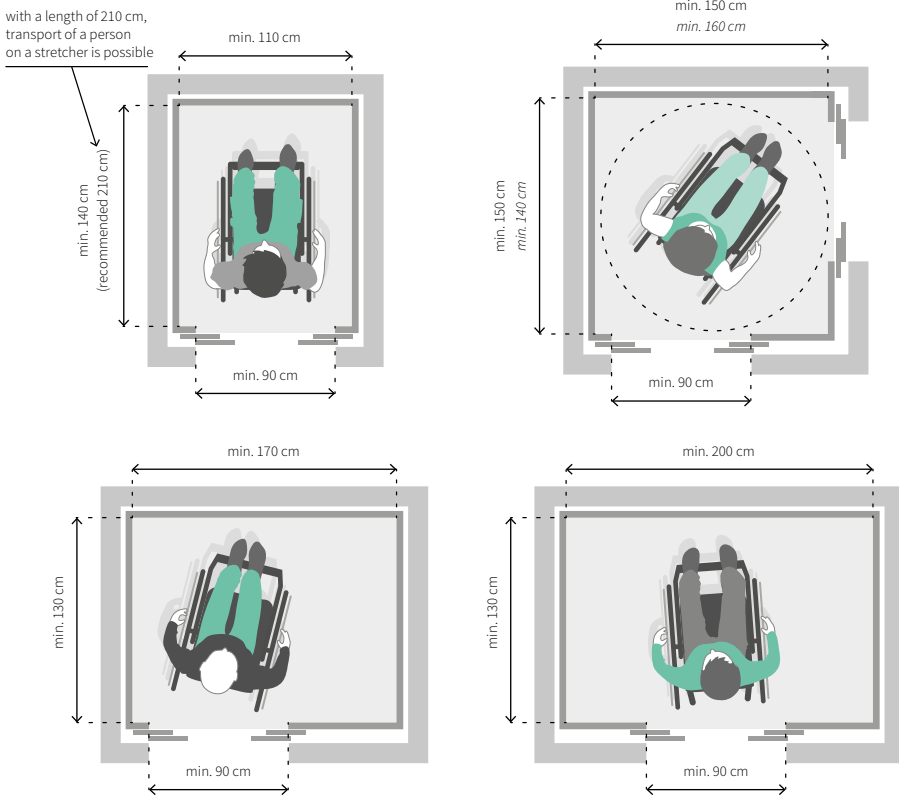

Dimensions of passenger lift cabins depending on the position of the entrance to the cabin. Prepared on the basis of the Regulation of the Minister of Infrastructure on the technical conditions to be met by buildings and their location, ISO 21542:2021 and ADA. Standards for Accessible Design.

DOORS

The width of the entrance door shall not be less than 90 cm in clear passage width.

For passenger lifts, the distance between the entrance door of the cabin and the opposite wall on the landing floor must be a minimum of 160 cm, while for hospital lifts it must be min. 300 cm⁵⁴.

⁵⁴ Regulation of the Minister of Infrastructure on the technical conditions to be met by buildings and their location, § 195.

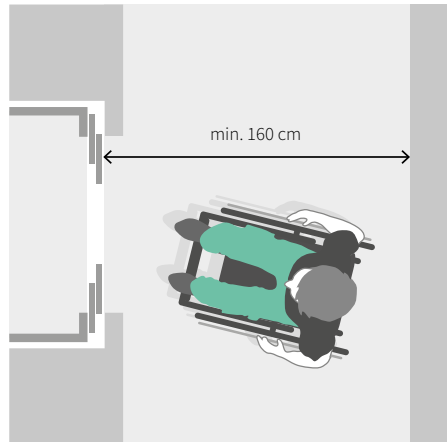

Distance between the cabin door and the opposite wall, min. 160 cm. Applies to the external part of the cabin.

Doors must be fitted with a light curtain to stop the door closing even before contact is made with a person entering or leaving. Sensors must also react to people of different heights, wheelchair users and children.

MIRROR

If the dimensions of the cabin do not allow free manoeuvring of the wheelchair (cabin smaller than 150 x 150 cm or 140 x 160 cm), a mirror should be fitted opposite the entrance to allow the wheelchair user to check that he/she can safely exit the lift cabin – in this situation the wheelchair user must leave the cabin facing backwards.

The bottom of the mirror must not be higher than 100 cm, with a recommended height of 30 cm from the cabin floor⁵⁵.

The upper edge of the mirror must be adapted to the needs of the able-bodied and must be at a height of at least 190 cm.

⁵⁵ Cf. ISO 21542:2021, clause 8.5.5.4..

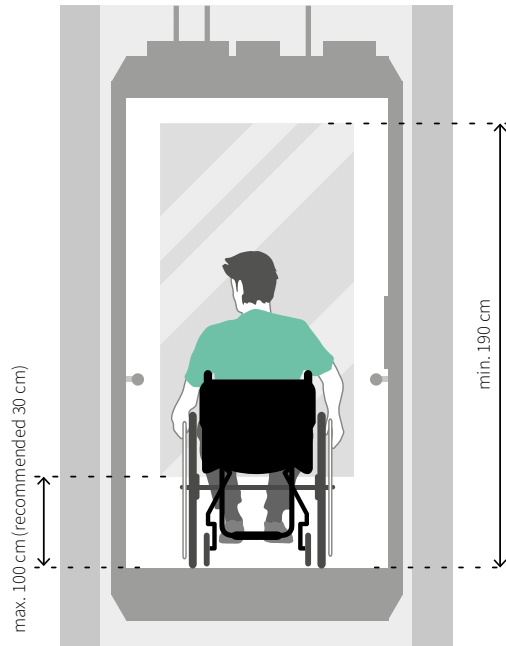

Location of the mirror in the cabin. On the wall opposite the entrance (bottom not higher than 100 cm, 30 cm recommended; top min. 190 cm).

HANDRAILS

For people with balance disorders, the elderly and those with mobility impairments, handrails installed in the cabin to enable them to hold on while driving are important. Handrails should be placed at least along one side of the cabin, at a height of 90 cm (measured to the top surface of the handrail)⁵⁶. However, it will be beneficial to place them on two or three walls.

6.3. Control panels

LOCATION OF CONTROL PANELS (TRADITIONAL AND DCS PANELS⁵⁴)

All buttons on the control panels outside and inside the cabin must be at a height of 80-120 cm⁵⁷. From the point of view of wheelchair users and children, it is advantageous to lower the upper limit to 110 cm.

⁵⁶ Cf. Regulation of the Minister of Infrastructure on the technical conditions to be met by buildings and their location, § 193(2a).

⁵⁷ Ibid.

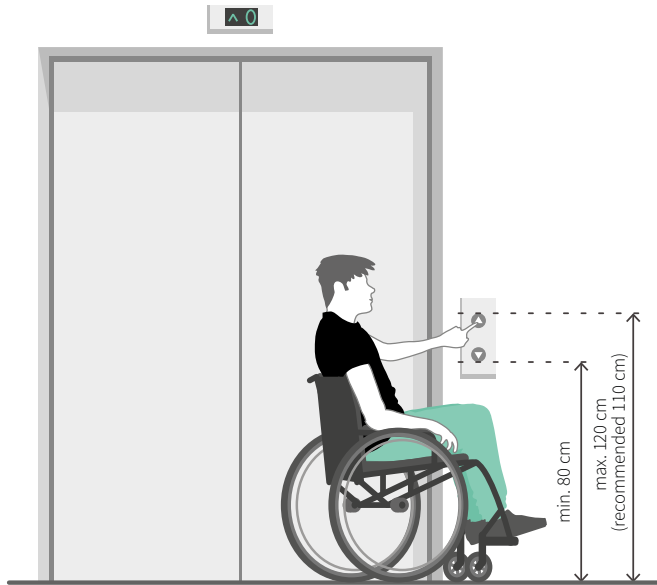

Height of control panels 80-120 cm (recommended 80-110 cm).

Control panels located too close to the corner of the cabin or walls may prove difficult or impossible to operate for wheelchair users, so this distance must not be less than 50 cm for internal panels and 60 cm for external panels⁵⁸.

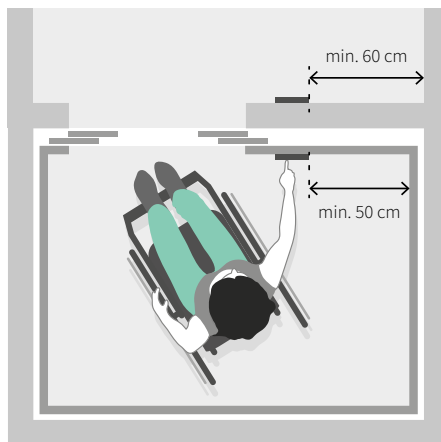

Position of the control panel in relation to the corner of the cabin or the corner of the lift lobby walls.

⁵⁸ Polish regulations only specify the distance of the panels from the corner of the cabin – Regulation of the Minister of Infrastructure on technical conditions to be met by buildings and their location, § 193(2a).

It is good practice to place the control panels in the same way on each floor:

- single cabin – to the right of the entrance,
- several cabins on one wall – minimum one panel for every 4 cabins, placed between the entrances,
- cabins on different walls – minimum one panel on each wall where cabins are located,
- interior panel – on the right-hand wall, looking from the entrance to the cabin.
If the cabin has several pairs of doors, consider the situation for doors opening at ground level or place panels on both sides of the cabin.

Exterior panels on each floor should be placed at the same height and in the same location to make them easy to find for people with visual impairments.

The rules outlined also apply to lifts equipped with DCS. In their case, the rules for internal panels should refer to the function buttons, e.g. alarm, door opening and closing.

TRADITIONAL CONTROL PANELS

Buttons must have a diameter or length of the shorter side of not less than 2 cm. Otherwise it may be difficult for a person with a manual disability to press the button.

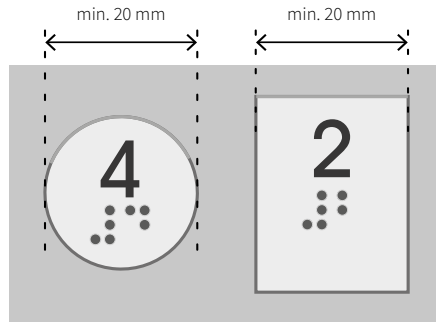

Minimum size of buttons on control panels.

For the same reason, buttons should be convex.

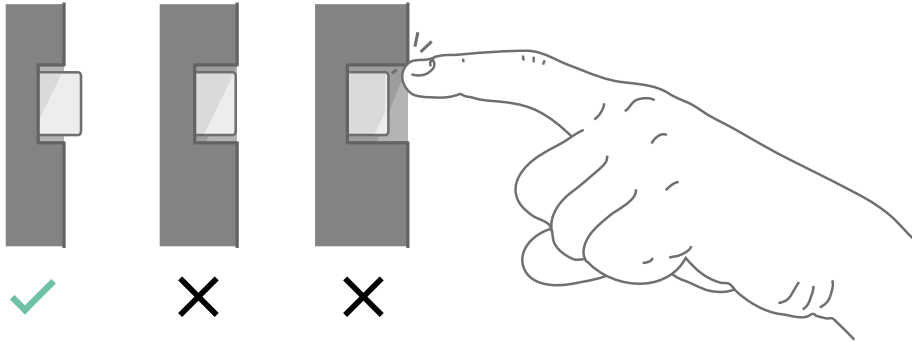

The way buttons on control panels should be designed. On the left, a convex button – the most favourable; in the middle, a button flattened against the panel surface; on the right, a concave button – making the panel difficult to use for people with manual disabilities.

For the sake of visually impaired people, the use of touch panels is not acceptable, even if tactile markings are placed on them. In such a situation, trying to read the inscriptions will result in pressing more buttons.

In the lift cabin it is advantageous to additionally mark the button indicating the ground floor, preferably by means of colour and tactile distinction (e.g. wider frame, larger convexity or size of button).

For the sake of visually and hearing impaired persons, it is recommended to confirm the acceptance of an order by a visual and audible signal at the same time..

When the lift is called, the blind or partially sighted person should be directed to the correct entrance by an acoustic signal coming from the direction of the entrance to the specific cabin.

DCS – DESTINATION CONTROL SYSTEM

It is difficult to imagine a modern office building without lifts with DCS. However, operating this type of system is difficult for visually impaired people. It can be a problem to find where to put the access card, to select the right floor, and to find the right cabin.

There are a number of measures that can be taken to facilitate the use of lifts by blind and partially sighted people, but regardless of these, assistance from a member of reception staff or building security may be required.

Floor selection

The method of floor selection will depend on the system used.

Types of DCS – mode of operation, advantages and disadvantages

Type of system	Method of operation	Pros and cons
Touch panels	The panel displays the floors that can be selected. It is necessary to press the button corresponding to the selected floor on the screen.	Panels of this type are inaccessible to people with visual impairments. Their use should be avoided.
Touch panels with a separate button for people with disabilities	The system works as with a normal touch panel. Pressing a button activates voice commands that instruct how to use the panel. Typically, the next available floor is read out loud to the person, and pressing the button again while the desired floor is being read out validates the selection.	Operating the system can be troublesome for someone who has not used it before, and floor selection by an employee with access to multiple floors can be time-consuming.

Type of system	Method of operation	Pros and cons
Panels with traditional numeric keypad, with voice messages	The floor number is entered on the numeric keypad. Pressing the button for people with disabilities triggers voice announcements reading out instructions on how to proceed and the numbers of accessible floors	Blind people are usually familiar with the layout of the numeric keypad. If a raised dot is placed on the '5' key, they should be able to locate the position of the other keys
Lift assignment after using a card at the access control gate	The lift is allocated when the card is used at the access control gates. Irrespective of this, it is necessary to provide control panels near the lifts, e.g. for those with access to multiple floors	With this type of system, it is very difficult for a visually impaired person to indicate the location of the appropriate cabin, especially when the access control gates have not been placed directly opposite the lift lobby

In some buildings, entitlements must be confirmed with an access card before the floor can be selected. In this situation, additional modes can be programmed on the card, such as a disabled person mode. In such a mode, solutions such as voice announcements, longer opening of cabin doors, assigning fewer people to a cabin, calling the lift closest to the panel in use can be activated.

Sometimes, in addition to the solutions described in the table, a floor can be selected by holding the access card at the reader for a long time. When the card is held down, the numbers of the successive storeys are read aloud and the selection is made by moving the card away. Unfortunately, such a system does not work if the person using the lift does not have an access card, e.g. a medical centre has been provided on one of the floors, which does not require a card.

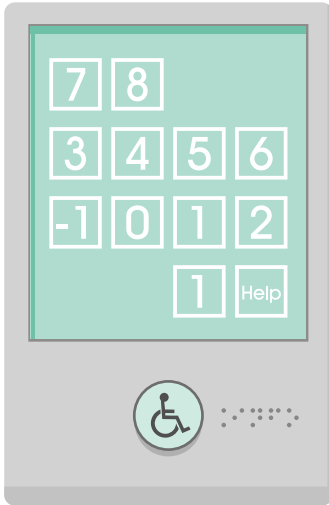

Touch panel with voice control button.

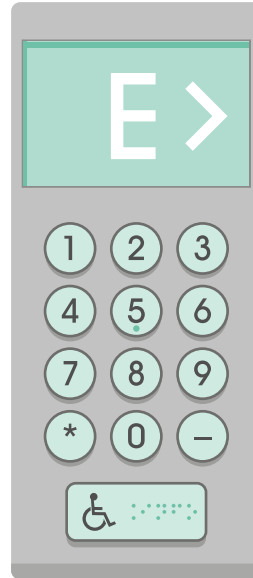

Numeric keypad with voice control button.

The button for activating the disabled operation mode should follow the principles described for buttons on conventional control panels. Its shorter side or diameter shall not be less than 2 cm, shall be convex and shall be marked visually (with a suitable pictogram) and tactilely.

Cabin indication

Once the floor has been selected, it is necessary to indicate the allocated cabin to the visually impaired person. It is not sufficient to give only the cabin number, as a blind person will not be able to read the signs placed near the entrances to the lifts. It is therefore necessary to provide precise messages indicating the location of the lift, e.g. 'Lift A - first on the right' or 'Lift B - on the opposite wall, first on the left'.

These messages must be adapted to the position of the panel currently used by the visually impaired person.

Other facilitations

Lifts with DCS allow for a number of additional settings that can only be activated for selected people, such as those using disability mode. These include:

- longer door opening – beneficial for people with movement disabilities and the visually impaired,
- always assigning the same cabin – easier for visually impaired people to find the lift,
- additional acoustic signal transmitted from the cabin – will make it easier for the blind to find the cabin,
- reduction in the number of persons assigned to a cabin – more space for a wheelchair user.

Assistance from employees

Regardless of the solutions used, reception and security staff should be sensitised to the needs of people unable to operate the DCS. This can be a problem not only for people with visual impairments, but also for other users, such as the elderly.

6.4. Information

Visual signs are illegible for blind people, auditory signs for people with hearing disabilities and tactile signs for people who have not been taught how to use them. Therefore, particularly relevant information must be conveyed in at least two ways: image and sound or image and touch. It is also possible to use 3 information systems simultaneously. A combination of only auditory and tactile information should be considered unfavourable. Such information will be difficult to understand for deaf and hearing-impaired people

INFORMATION ON EXTERNAL CONTROL PANELS

The design principles of the markings on the external control panels, depending on the number of buttons and their position, are shown in the table below.

Principle of designing calling panels in a way that is accessible to people with visual impairments

Type of panel	Button layout	Information
Single button	–	Information is not necessary – the function of the button is clear.
2 buttons (go up, go down)	The buttons must be positioned one above the other – the travel up button above, the travel down button below.	<p>Information is not necessary.</p> <p>The following indications may be provided:</p> <ul style="list-style-type: none"> • up and down arrow-shaped buttons, • convex up and down arrows on the buttons, • Braille inscriptions: ‘Up’, ‘Down’. <p>A combination of arrows and Braille signs is possible.</p>
More buttons or buttons with specific functions	For the up and down buttons, the principle described above should be followed. The layout of the other buttons should be as intuitive as possible, e.g. if an additional button is used to call for a lift going to the garage, it should be placed at the bottom.	The up and down buttons shall be marked as described above. The other buttons shall be marked according to their function with a convex symbol or abbreviation and Braille lettering.

Type of panel	Button layout	Information
DCS panel	As indicated in chapter 6.3 (p. 145).	It is necessary to mark individual lifts with consecutive numbers. The contrast of the markings against the background should be min. 60% on the LRV scale.

In buildings where some floors have distinctive functions, e.g. garages, a floor with meeting rooms, it is good practice to place information about the functions of these floors near the call panels.

This information should be presented simultaneously by means of:

- pictograms – if the function of the floor allows it,
- text – in addition to pictograms or when it is not possible to represent a function in pictogram form,
- Braille signs.

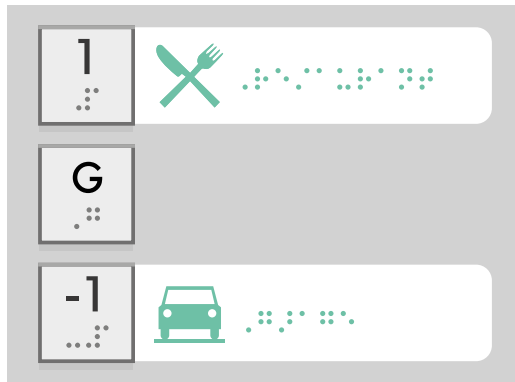

Control panel with push buttons and information next to them on the functions of the selected floor (pictogram, Braille signature).

INFORMATION ON INTERNAL CONTROL PANELS

The following tactile information shall be provided on or immediately adjacent to the buttons located inside the cabin⁵⁹:

- floor number (not applicable to lifts with DCS):
 - plain figures – height min. 15 mm, relief min. 0.5 mm, contrast of characters against background min. 60% LRV,
 - information in Braille;
- function keys – opening and closing doors, alarm, etc. (also applies to lifts with DCS):
 - pictograms – height min. 15 mm, relief min. 0.5 mm, contrast of characters against background min. 60% LRV,
 - information in Braille⁶⁰.

The tactile markings must be convex, otherwise they cannot be read correctly.

CABIN ARRIVAL SIGNALLING

Signalling the arrival of a cabin makes it easier to find the correct lift. It can be difficult for visually impaired people to find their allocated cabin without an appropriate acoustic signal, so it is necessary to direct the user by means of a signal coming from the lift entrance side (a buzzer located, for example, above the door) or from inside the open cabin. This type of information is particularly important if there are several lifts in the lift lobby.

For lifts with DCS, a visually impaired person needs precise voice information about the location of the selected lift. For more information, see chapter 6.3 (p. 145).

EXTERNAL INFORMATION ON FLOORS

For the person riding in the lift, it is important to know the number of the floor they are currently on. Large signs, placed opposite the cabin entrance, enable the person in the lift to confirm that they are getting off on the correct floor.

Displays on the floor showing the current position of the cabin, or at least the direction of travel, enable the person waiting for the lift to ascertain whether the lift is going and how long they will have to wait for it. Such solutions are not necessary in lifts equipped with DCS.

⁵⁹ Cf. Regulation of the Minister of Infrastructure on the technical conditions to be met by buildings and their location, § 193(2a)..

⁶⁰ Function buttons are often marked with abbreviations in English, which are not very legible for visually impaired people in Poland. This is most likely due to the fact that illustrations showing writing patterns in Braille have not been translated in the Polish versions of the norms and standards.

INFORMATION INSIDE THE CABIN

The following types of information are relevant in the lift cabin:

- a voice message giving the number of the floor on which the lift currently stops, e.g. 'Ground floor. Exit from the building'. – without this type of information, it will be difficult for a visually impaired person to know when they should leave the cabin;
- a display showing the current location of the cabin and the direction of travel. In the case of a lift equipped with a DCS, all floors where the lift will stop should also be displayed.

EXAMPLES OF BRAILLE SIGNS

Many people do not realise that Braille is only a form of text recording and can be used in different languages. It is often incorrectly referred to as 'Braille language'. In lift standards, the most common examples of markings are made using abbreviations in English, which may not be readable by Polish speakers.

It also happens that the sign manufacturer takes advantage of the lack of knowledge of the builder and introduces a set of random signs or installs the signs upside down.

The following illustration shows examples of braille button markings in Polish.

It should be remembered that Braille is not to scale, so it is important to keep the point sizes and distances between them constant.

Floor numbers:

-3		5		13	
-2		6		14	
-1		7		15	
G		8		16	
1		9		17	
2		10		18	
3		11		19	
4		12		20	

Elevator control buttons:

Emergency Stop		Door Close	
Alarm		Main Entry Floor	
Door Open		Phone	

- convex points in the shape of a dome
- Empty points. There is an empty space in their place but they are still a part of a sign. If the whole first or last column consists of empty points only, the area occupied by empty points needs to be taken into consideration while determining the margins.

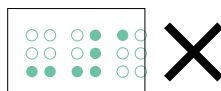
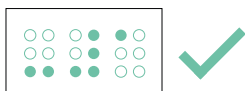

Indicators in the Braille alphabet are presented in 1:1 scale. The Braille alphabet is not scalable.

Przykładowe oznaczenia w alfabecie Braille'a.

6.5. Other vertical transport equipment

Passenger lifts can be replaced by vertical lifts with or without a shaft, stair lifts and other devices. However, vertical lifts have a number of disadvantages. They are not very versatile – a parent with a pram or a cyclist is unlikely to use one. They move slowly and usually require a button to be held down continuously while moving. For these reasons, vertical lifts should be installed as a last resort when technical considerations or space do not allow the installation of a passenger lift.

CHOICE OF TECHNICAL EQUIPMENT

The following table describes the advantages and disadvantages of each device.

Comparison of different types of vertical transport equipment

	Passenger lifts
Cabin	Full walls. No contact with the shaft. Full safety for users.
Cabin/platform size	Regulated by legislation that ensures appropriate size.
Operation	A single press of the button.
Speed	Limited by technical conditions.
Power supply	Constant.
Can be used by different groups of people	Unrestricted. Can be used by, among others, people with disabilities, cyclists, parents with prams.

	Vertical lifts with a shaft
Cabin	<p>No side walls. Direct contact with the shaft. May pose a hazard to users. It is possible to order a lift with an enclosed cabin, but this increases the price of the device.</p>
Cabin/platform size	<p>Unregulated. Inappropriate lift may be too small for some wheelchair users.</p>
Operation	<p>Having to hold the button continuously while calling or driving the lift – difficult to operate. In a lift with an enclosed cabin, the buttons can operate as in a normal lift.</p>
Speed	<p>Significantly reduced for safety reasons.</p>
Power supply	<p>Constant.</p>
Can be used by different groups of people	<p>Operating the device is difficult for people with manual disabilities due to the need to hold the button down at all times. In practice, it is also difficult for able-bodied people who do not always know how to use such a device.</p>

	Vertical lifts without a shaft
Cabin	No shaft or external walls. There is a risk of someone stepping under the lift, which can be prevented, e.g. by using rubber flanges and systems to stop the device moving when it comes into contact with an obstacle.
Cabin/platform size	Unregulated. Inappropriate lift may be too small for some wheelchair users.
Operation	Need to continuously hold the button while calling or riding the lift – difficult to operate.
Speed	Significantly reduced for safety reasons.
Power supply	Constant.
Can be used by different groups of people	The devices are primarily designed for people with mobility impairments. Operation of the device presents the same difficulties as with shaft lifts.

	Stair lifts (platforms)
Cabin	<p>No shaft or external walls.</p> <p>When in use, the lift restricts the width of the staircase and, in extreme situations, can make it completely unusable.</p>
Cabin/platform size	<p>Unregulated.</p> <p>Inappropriate lift may be too small for some wheelchair users.</p>
Operation	<p>The need to hold the button continuously.</p> <p>Due to the complex operation of the device, using it very often requires the assistance of a third party.</p>
Speed	<p>Significantly reduced for safety reasons.</p>
Power supply	<p>Charging of the battery usually takes place in the rest position.</p> <p>With a large number of people being transported in direct succession, there is a risk of the battery discharging during the ride.</p>
Can be used by different groups of people	<p>The device is designed for people with mobility impairments and does not facilitate eg. parents with prams.</p> <p>If the device is not selected correctly, it may not be possible to transport people using large or heavy wheelchairs (usually electric).</p>

	Stair climbers
Cabin	A portable device, not tied to a building. When in use, the stair climber restricts the width of the staircase and, in extreme situations, can make it completely unusable.
Cabin/platform size	Not applicable – transport takes place after the wheelchair is clipped into the device or the person is transferred to the stair climber seat.
Operation	It is not possible to operate the device without the assistance of a third party. In practice, this type of equipment is used very infrequently and may therefore be unprepared for use (uncharged battery, deflated wheels)..
Speed	Significantly reduced due to the way the device works and the need for third party operation.
Power supply	Mechanical equipment requires charging when stationary. Manually operated equipment does not require recharging.
Can be used by different groups of people	A device designed exclusively for people with mobility impairments. Only certain types of wheelchair may fit into the device, or it may be necessary to transfer to a special wheelchair or stair climber seat. Most often it is not possible to transport electric wheelchairs. People with disabilities are afraid to use this type of equipment.



Stair climber. Device not recommended for use in public buildings.

In new buildings, it should be considered unfavourable to replace lifts with vertical lifts, even in situations where they are intended to overcome small height differences. People with upper limb disabilities may find it difficult to operate them.

The use of such platforms can be considered in existing facilities if, for technical reasons, it is not possible to install a passenger lift.

Stair lifts are permitted where technical conditions do not allow other solutions to be used, and only in existing buildings subject to adaptation..

Stair climbers should not be used in any type of public building, including adapted facilities. People with disabilities are reluctant to use them and their use presents numerous technical difficulties.

VERTICAL LIFT WITH A SHAFT

Vertical lifts with a shaft allow several floors to be covered.

This type of lift can be used in existing buildings if the space available does not allow a full-size lift to be installed. Because of the difficulty for people with reduced mobility, this type of lift should only be used in exceptional situations.

The dimensions of the lift platform with self-supporting shaft must correspond to those specified for passenger lift cabins as described in chapter 6.2 (p. 142). In particularly difficult situations, it may be possible to limit the size of the cabin to 125 x 90 cm, although this may prove too small for people in large wheelchairs and those using an assistant.

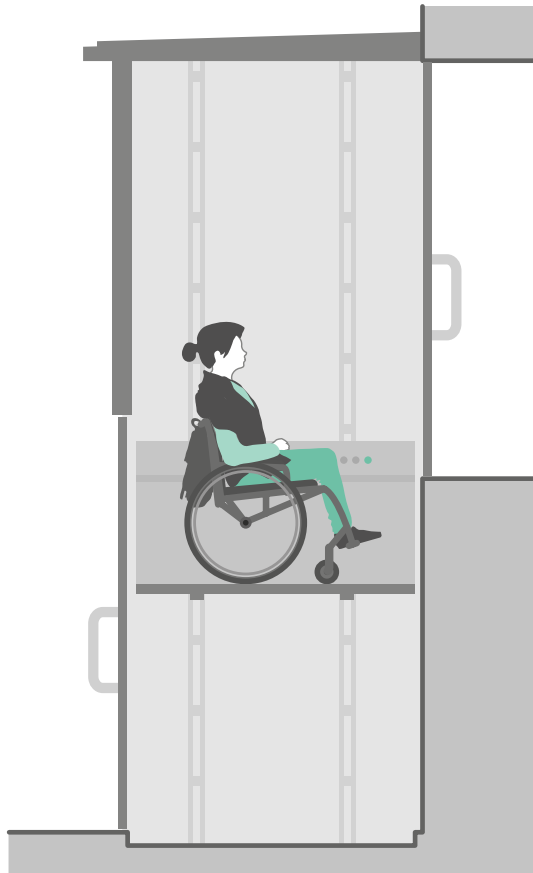

Vertical lift with a shaft.

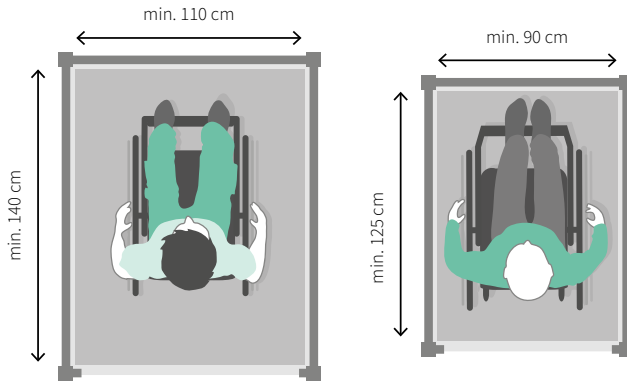

Dimensions of the vertical lift platform with shaft. On the left, recommended dimensions, on the right, acceptable in exceptional situations

The heaviest electric wheelchairs can weigh up to 150 kg, and together with the person sitting on it, the weight can exceed 230 kg. The load capacity of a vertical lift with a safety margin must therefore not be less than 300 kg.

As with passenger lifts, the width of the entrance door must not be less than 90 cm in clear passage.

From the point of view of people with reduced mobility, automatic or semi-automatic opening doors are preferable. Such doors shall be fitted with sensors to stop them closing.

A manoeuvring space of at least 150 x 150 cm must be provided in front of the entrance. This space may not be restricted by the opening area of the door..

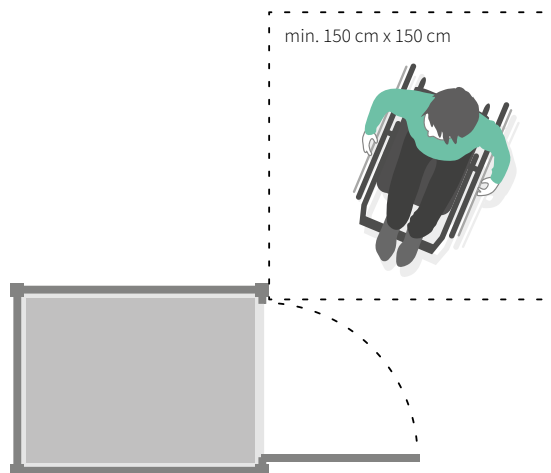

Minimum manoeuvring space in front of the lift entrance.

The parameters of the control panels should be in accordance with the guidelines for panels in passenger lifts as described in chapter 6.3 (p. 145). Because of the need to hold the button at all times during the ride, the panels should be inclined so that it is possible to rest the hand on them. It is possible to order a lift with a closed cabin. In this case, the control works as in a normal lift – it is sufficient to press the button once. However, this is an additional solution, increasing the cost of the device..



Inclined control panel to make it easier to hold the button while using the lift.

VERTICAL LIFT WITHOUT A SHAFT



Vertical lift without a shaft.

Vertical lifts without a shaft allow small height differences to be overcome, e.g. changes in level within a floor.

The most favourable situation is where there are no changes in levels on the floor. However, even in newly designed buildings this is not always avoidable.

The reason for this can be, for example, large changes in ground levels forcing the placement of entrances at different levels. Where height differences cannot be avoided within a floor, it is best to design a ramp. Lifts should only be used in existing buildings where the amount of space available does not allow a compliant ramp to be built.

The platform of a vertical lift without a shaft must not be less than:

- if the door is positioned on the shorter side – 90 x 125 cm,
- if the door is placed on the long side or on the short side and on the long side – 150 x 150 cm or 140 x 160 cm.

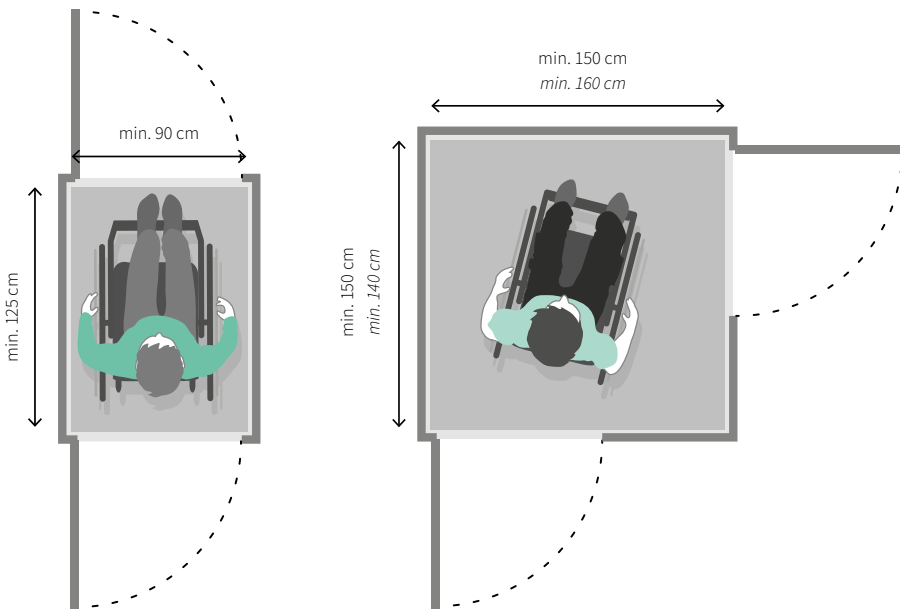

Minimum dimensions of vertical lift without a shaft.

The lift capacity must not be less than 250 kg, but it will be preferable to provide a lift capacity of min. 300 kg.

Lift doors can be opened manually, semi-automatically or automatically and must not be less than 80 cm wide. However, a width of not less than 90 cm is recommended.

A manoeuvring space of 150 x 150 cm shall be provided in front of the door, unrestricted by the door opening area.

The parameters of the control panels must correspond to those specified for vertical lifts with shafts.

In the case of lifts without a shaft, there is a risk of the user stepping under the lift when it is on the top landing, so it is necessary to equip these types of equipment with systems to stop the device on contact with an obstacle or special flanges to fill the space under the lift.

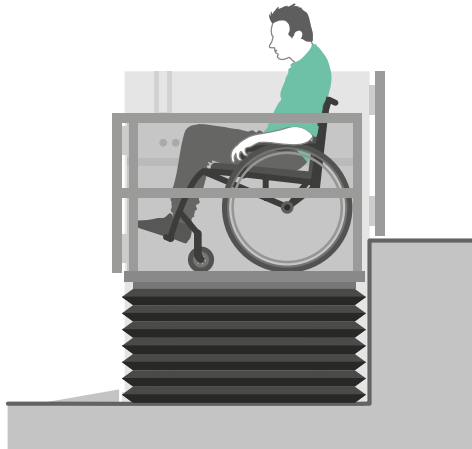

Vertical lift with rubber flange to prevent entry under the device.

STAIRLIFTS/ INCLINED LIFTS



Stairlift.

Stair lifts, otherwise known as inclined lifts, are installed along a flight of stairs. They are usually used to overcome small differences in height, but it is also possible to install them between floors.

These types of devices only serve wheelchair users. When used, they restrict the width of the walkway, making it difficult to use the stairs. People with disabilities are reluctant to use this type of device, not least because of the slow speed and the difficulty in operating them.

Stair lifts should be installed as a last resort, once other options have been ruled out. They should not be used in new buildings.

The dimensions of the stair lift platform must not be less than 80 x 100 cm and the load capacity must not be less than 250 kg (recommended, min. 300 kg).

OTHER TYPES OF LIFTING EQUIPMENT

Other types of lifting equipment are also available on the market, such as floor or stair retractable lifts.

In the first situation, a small landing is made from which a lift is ejected. In the second, all the steps descend to one level to form a lift

This types of equipment is a good solution for historic buildings and particularly difficult situations in existing buildings.

Their parameters should correspond to those of vertical lifts.

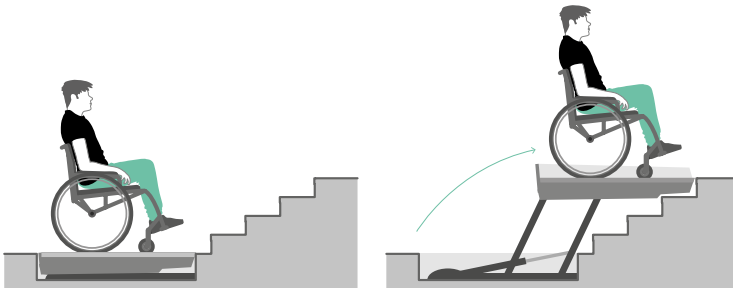

Lift hidden in the floor.

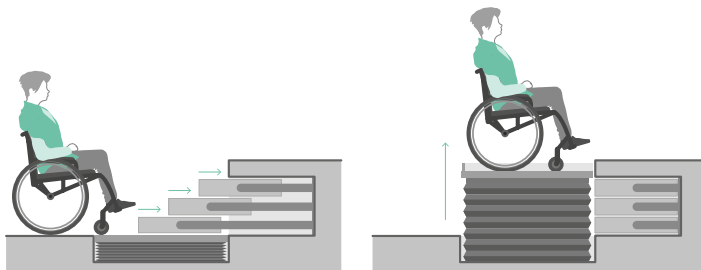

Lift hidden in the stairs.

IMPORTANT PARAMETERS

CABIN SIZE

Door located on the shorter side of the cabin: min. 110 x 140 cm.

Cabin with wheelchair to be turned: min. 150 x 150 or min. 140 x 160 cm.

Door placed on the long side, close to the corner: min. 130 x 170 cm.

Door positioned on the long side, close to the centre: min. 130 x 200 cm.

DOORS

Width: min. 90 cm.

Door distance from door to wall on landing floor: min. 160 cm.

Door stop sensors: detecting obstacles at different heights and acting before contact with the obstacle occurs.

MIRROR

Position of mirror: in cabins with dimensions below 150 x 150 cm or 140 x 160 cm opposite the entrance.

Lower edge of mirror: not higher than 100 cm (30 cm recommended).

Upper edge of mirror: min. 190 cm.

HANDRAILS

At least on one side of the cabin, at a height of 90 cm.

Recommended on two or three sides.

LOCATION OF CONTROL PANELS

Button position height: 80-120 cm (recommended 80-110 cm).

Distance from the corner of the wall or cabin: min. 50 cm.

Additional recommendations: uniform position of panels in relation to the lift entrance throughout the building.

TRADITIONAL CONTROL PANELS

Diameter or length of the shorter side of the button: min. 20 mm.

Type of buttons: convex (protruding above the panel surface).

Touch panels: not acceptable.

Additional solutions: highlighting the button indicating the ground floor.

Confirmation of command reception: simultaneous visual and audible signal recommended.

OTHER VERTICAL TRANSPORT DEVICES – DECISION-MAKING PROCESS

Decision-making process for selecting technical devices (from most favourable to least favourable):

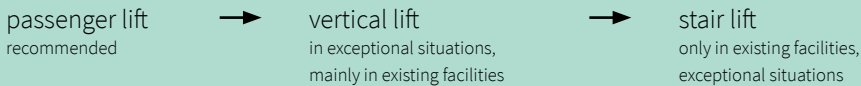

LIFTING EQUIPMENT

Use: only in exceptional situations, not recommended for new buildings.

Vertical lifts with a shaft

Platform dimensions: in accordance with the dimensions provided for passenger lift cabins.

Lifting capacity: min. 300 kg.

Clear passage door width: min. 90 cm.

Control panels: panel inclined to allow the hand to rest while holding the button, button parameters and markings in accordance with the requirements for passenger lifts.

Additional solutions: recommended choice of closed cabin (buttons work as in a lift).

Vertical lifts without a shaft

Dimensions of platform – door on the short side: min. 90 x 125 cm.

Dimensions of platform – door on the long side or on the long and short side: min. 150 x 150 cm or min. 140 x 160 cm.

Load capacity: min. 250 kg (recommended min. 300 kg).

Clear passage door width: min. 80 cm (min. 90 cm recommended).

Control panels: Compliant with the requirements for shaft lifts..

Stair lifts/inclined lifts

Least favourable solution, to be avoided in new buildings.

Platform dimensions: min. 80 x 100 cm.

Load capacity: min. 250 kg (recommended min. 300 kg).

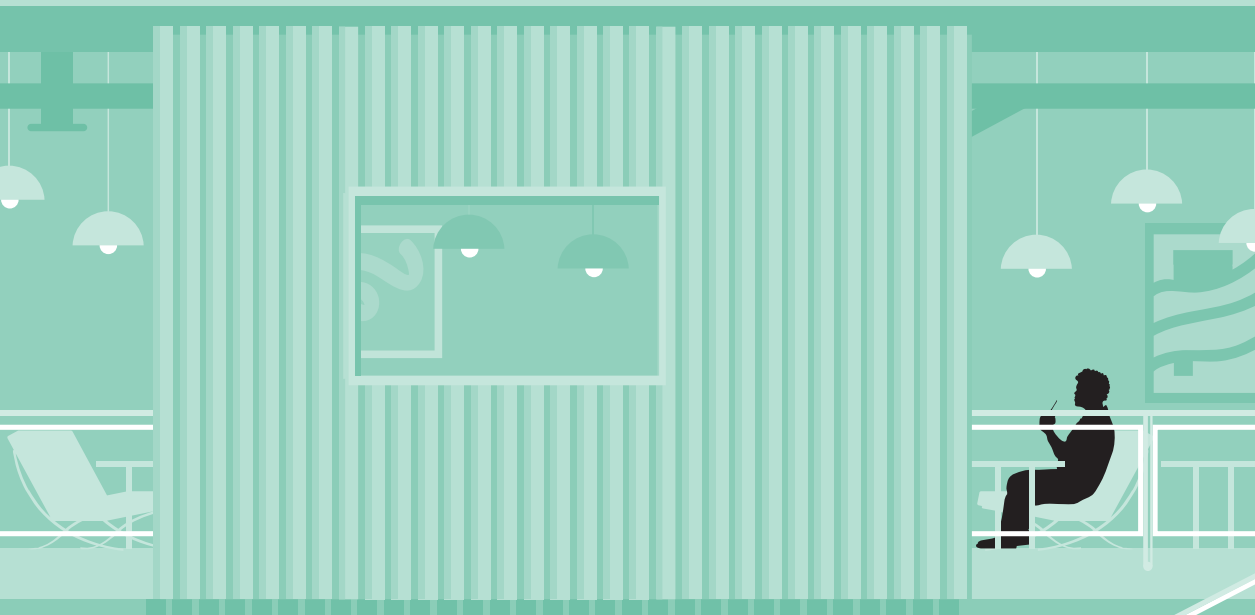



7

STAIRS – STAIRCASES AND STAIRS IN OPEN SPACES

7 | STAIRS – STAIRCASES AND STAIRS IN OPEN SPACES

7.1. Step parameters

The parameters of the steps are set out in the Regulation of the Minister of Infrastructure on the technical conditions to be met by buildings and their location. The regulations indicate the height and width of steps, the parameters of landings, as well as the rules concerning the placement of handrails.

Parameters of stair steps

	Parameters according to the buildings regulation ⁶¹	Recommended parameters according to ISO 21542:2021 ⁶²
Residential and public buildings	max. 17.5 cm	
Health care buildings, kindergartens and nurseries	max. 15 cm	max. 15 cm stairs of high traffic importance and stairs in escape routes
Garages	max. 19 cm	

The width of the steps is determined by the following formula:

$$2h + s = 60-65 \text{ cm}$$

h – step height, s – step width⁶³.

⁶¹ Regulation of the Minister of Infrastructure on the technical conditions to be met by buildings and their location, § 68(1).

⁶² Cf. ISO 21542:2021, clause 8.3.2.

⁶³ Regulation of the Minister of Infrastructure on the technical conditions to be met by buildings and their location, § 69(4).

In addition, for external stairs located at the main entrances to a building, the step width must not be less than 35 cm⁶⁴. Maintaining the comfortable parameters of the steps with such a width requires the provision of a height of not more than 15 cm.

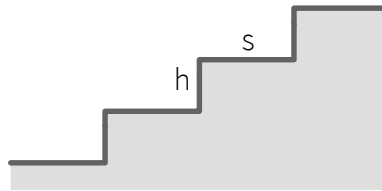

Principle of measuring step height and width.

It is also important to shape the step profile accordingly. Stairs without risers or steps with noses create a tripping hazard and should therefore be avoided. Steps designed at a right angle to the riser will cause the back of the shoe to snag when descending. It is best to design steps with a slightly sloping riser – the bottom edge of the riser set back a maximum of 25 mm from the top edge⁶⁵.

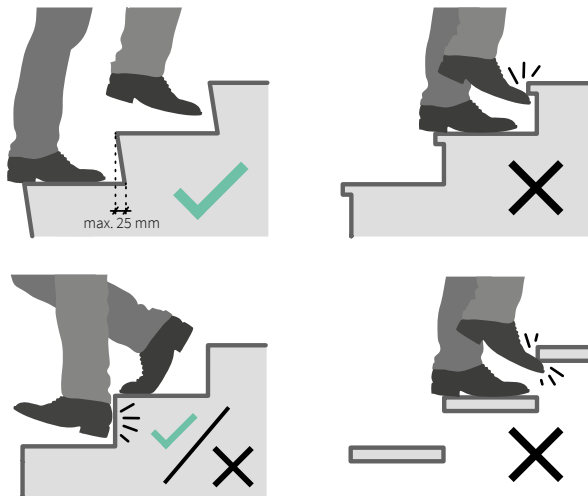

Different ways of shaping the step profile.

⁶⁴ Ibid, § 69(5).

⁶⁵ ISO 21542:2021, clause 8.3.2.

The usable width of a flight of stairs must not be less than 120 cm. Exceptions are stairs to garages min. 90 cm⁶⁶. The width of stairs must be measured between the handrails.

7.2. Length of stair flights and landings

The number of steps in a single flight of stairs must not exceed 17 in indoor stairs and 10 in outdoor stairs⁶⁷. A smaller number of steps in a flight allows for more frequent rests, which is why, for example, from the point of view of the elderly, it is advisable to design as short a flight as possible.

Flights that are too short should also be avoided. One or two steps are difficult to see and can lead to tripping, so flights of at least 3 steps should be designed.

Steps designed in public buildings must have a length of min. 150 cm and, in the case of stairs to garages, min. 90 cm⁶⁸.

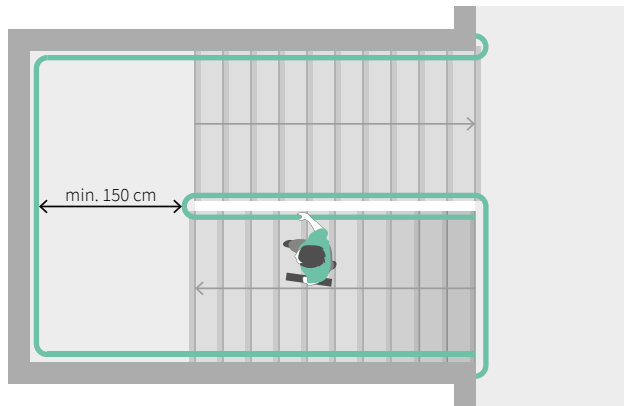

Minimum length of the landing.

⁶⁶ Regulation of the Minister of Infrastructure on the technical conditions to be met by buildings and their location, § 68(1).

⁶⁷ Ibid, § 69(1) and (3).

⁶⁸ Ibid, § 68(1).

On staircases with an evacuation function, it is recommended to enlarge the landings in order to provide a place for people with disabilities to wait for the assistance of rescue teams. These places should be designed so that the person waiting does not impede the evacuation of the others. This is known as a survival zone. It can also be located in a room with direct access from the stairwell, such as in a fire lift vestibule connected to it.

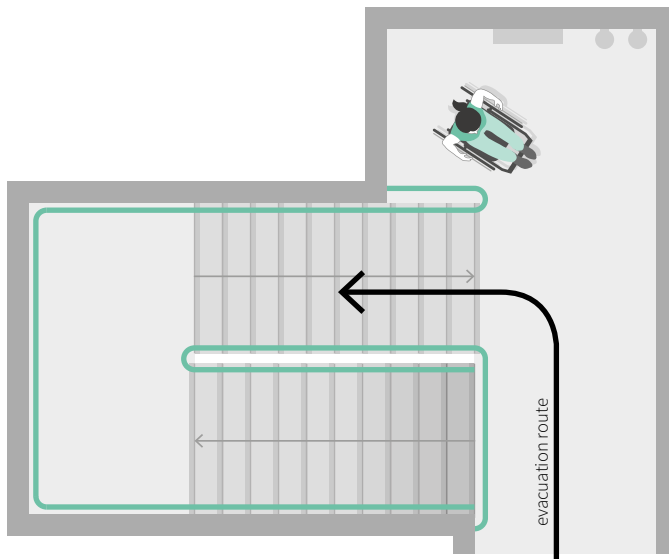

Floor landing with space provided to allow wheelchair user to wait for emergency teams.

7.3. Handrails

In buildings, the design of handrails is required for stairs that are more than 50 cm high. In this situation, handrails shall be provided on both sides of the flight of stairs⁶⁹.

If the width of the flight is greater than 4 m, additional intermediate handrails must also be provided⁷⁰.

⁶⁹ Ibid, § 296(1).

⁷⁰ Ibid, § 296(3).

The provision of handrails at stair heights of less than 50 cm is not required, but the installation of at least one handrail will be beneficial for the elderly and people with mobility impairments.

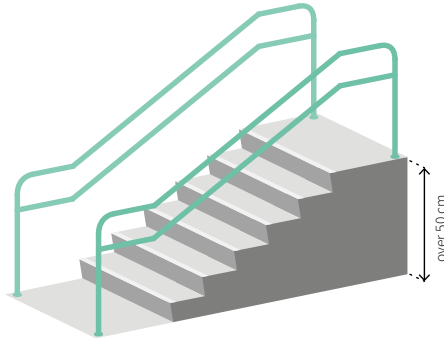

Stairs over 50 cm high handrail on both sides of flight.

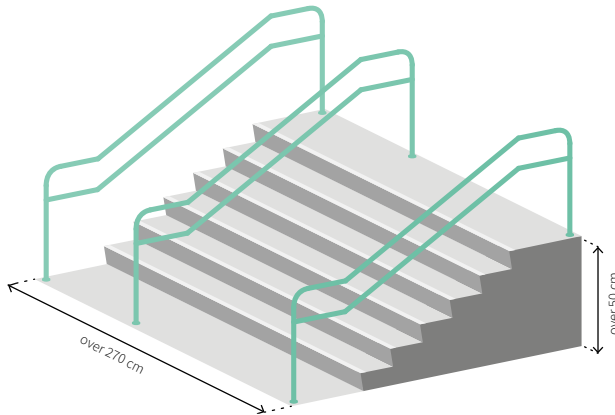

Stairs over 50 cm high and over 4 m wide handrails on both sides and an additional handrail in the middle.

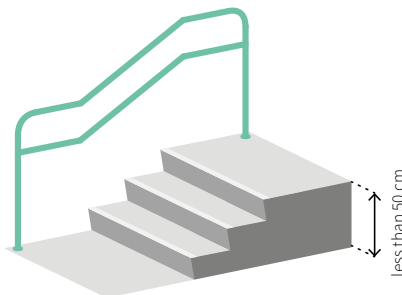

Stairs less than 50 cm high at least one handrail recommended.

Railings at the stairs are designed at a height of 110 cm, measured to the top edge of the railing, and the openings between the railing elements must not be greater than 20 cm⁷¹.

For children and short people, additional handrails installed at a height of 60-75 cm⁷² are helpful. Handrails of this type are particularly important in areas where more children can be expected (e.g. when a kindergarten is planned in the building).

In addition, on external stairs, the regulations require the handrail to be extended a minimum of 30 cm beyond the flight of the stairs⁷³. If the architectural layout of the building allows it, this solution will also be beneficial for internal stairs⁷⁴.

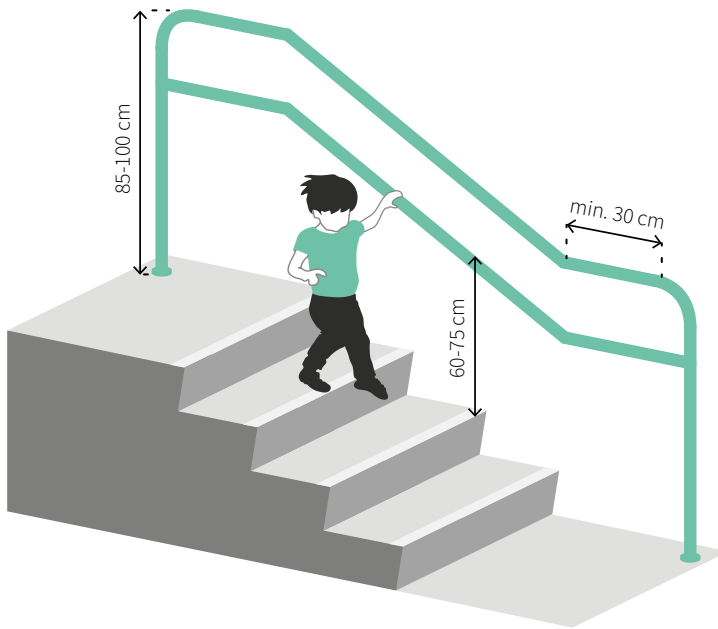

Handrails at various heights.

⁷¹ Ibid, § 298(2).

⁷² ISO 21542:2021, section 8.4.4.

⁷³ Regulation of the Minister for Infrastructure on the technical conditions to be met by buildings and their location, § 298(5).

⁷⁴ ISO 21542:2021, section 8.4.5.

Handrails must have no sharp parts and should be securely ended. They must also be installed at a distance of min. 5 cm from a wall or other obstacle⁷⁵.

The comfort and safety of using a handrail also depends on the shape of the handrail. The parameters of the handrail can be found, among others, in ISO 21542:2021 and in ADA. Standards for Accessible Design. The parameters specified in the ISO standard make it practically impossible to use a handrail with a rectangular cross-section, which is beneficial for people with manual disabilities. In the US standards, such a solution is acceptable provided that the appropriate perimeter and diagonal are maintained.

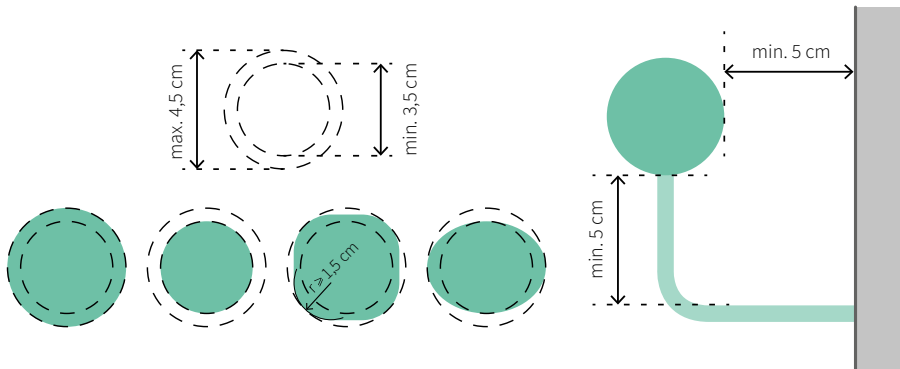

Principle for the design of the handrail profile based on ISO 21542:2021. The cross-section of the handrail must be able to be inscribed between two circles with diameters of 3.5 and 4.5 cm.

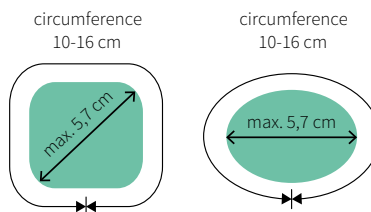

The principle of shaping the rake profile based on the ADA. Standards for Accessible Design. The longer diagonal or diameter of the handrail must be max. 5.7 cm, while the perimeter of the handrail must be between 10 and 16 cm.

⁷⁵ Regulation of the Minister for Infrastructure on the technical conditions to be met by buildings and their location, § 298(5) and (6).

For visually impaired people, it may be important to maintain a continuity of handrails on the treads, making it easier to recognise the further direction of movement. This is particularly important on stairs that are wide or that change direction in an unusual way. Visually impaired people will find the handrail easier if there is a high contrast between the handrail and the wall or other background. Such contrast should be in accordance with the principles described in subchapter LRV (p. 54).

It is helpful for visually impaired people to place tactile information in Braille on handrails. This type of information is usually placed at the beginning of the flight of stairs, on top or on the inside of the handrail. Such information may include the number of the floor to which the stairs lead and a description of the function of the floor, e.g. 'Level -1Garage'. The handrail is an advantageous location for this type of information as it is easy to find.

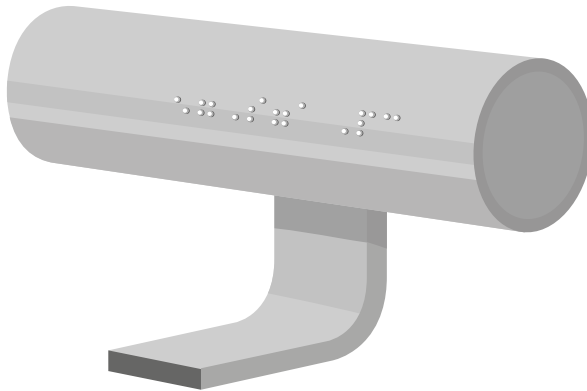

A plaque with information in Braille placed on the inside of the handrail. Due to the position of the hand, the writing on the inside of the handrail should be placed upside down.

7.4. Space under the stairs

For visually impaired people, the space underneath a flight of stairs can be dangerous. If the staircase starts on the ground floor or the staircase is designed in the open space of the entrance hall or another floor, a visually impaired person is not able to detect the obstacle with a cane and may hit their head on the underside of the stair structure.

In this type of situation, it is necessary to design solutions that prevent people from entering under the stairs where the height of the space is less than 210 cm⁷⁶.

Protective measures of this type can be made by introducing handrails under the stairs, but there are also other, more aesthetically pleasing methods. If the architectural form of the staircase itself is not important, the space underneath can be built up with solid walls. If the stair structure is to be an important element of the interior, flower pots can be placed underneath, or furniture can be arranged accordingly, e.g. surrounding the stairs with seating areas.

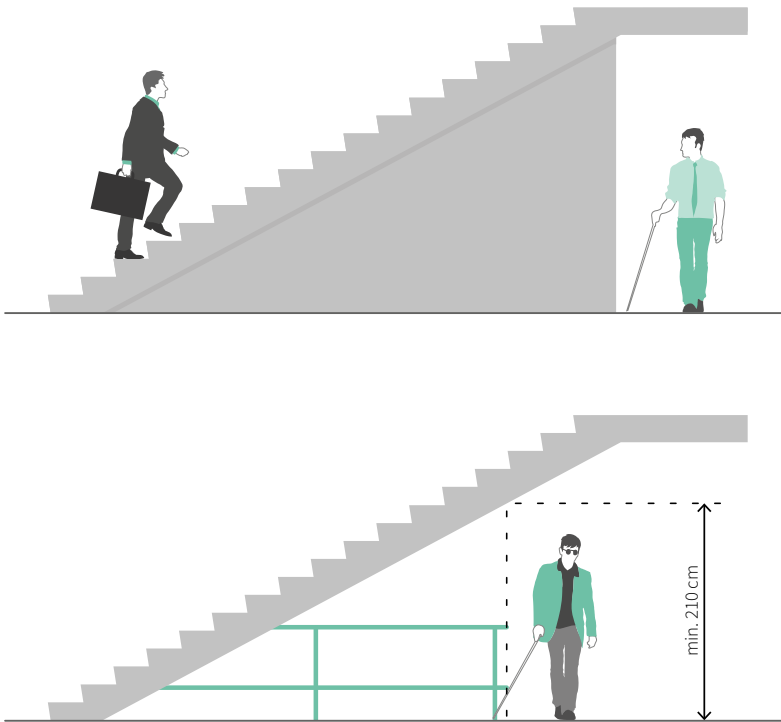

Different ways of securing the space under the stairs.

⁷⁶ ISO 21542:2021, section 8.3.5.

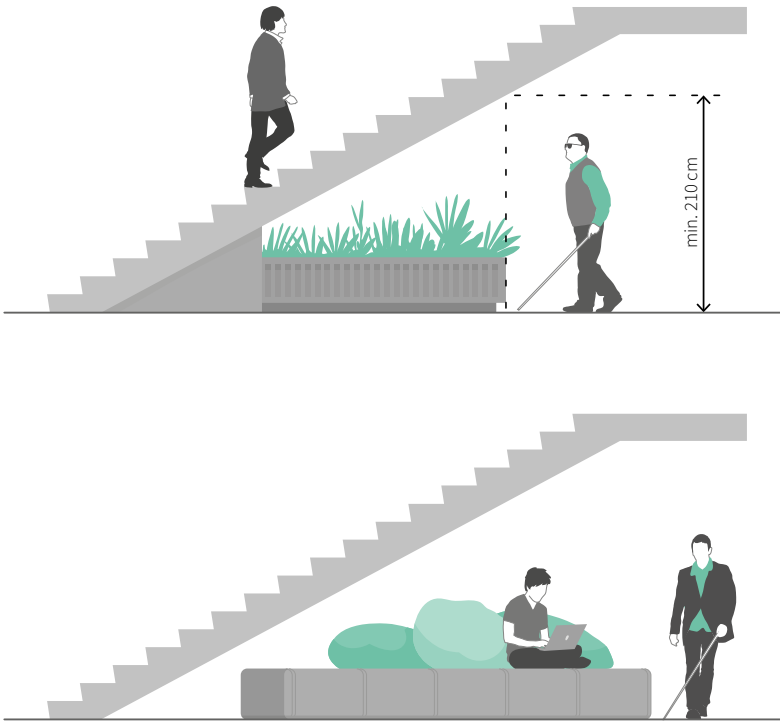

Different ways to secure the space under the stairs.

7.5. Visual and tactile markings

The Regulation of the Minister of Infrastructure on the technical conditions to be met by buildings and their location requires two types of signage to be used in public buildings:

- along the edges of the stepsmarkings contrasting with the colour of the floor⁷⁷,
- on landings within 30 cm of the starting and finishing edges of a flight of stairschange in shade, colour or texture⁷⁸.

The regulation does not indicate the specific parameters of the markings and the rules for their placement.

⁷⁷ Regulation of the Minister of Infrastructure on the technical conditions to be met by buildings and their location, § 71(4).

⁷⁸ Ibid, § 306(2).

VISUAL MARKINGS

Contrast markings can be made along the edges of all steps or only the first and last step in a flight of stairs. ISO 21542:2021 indicates that the width of the stripe should be 4-5 cm if all edges are marked, and 5-10 cm if marking is done only along the first and last step⁷⁹.

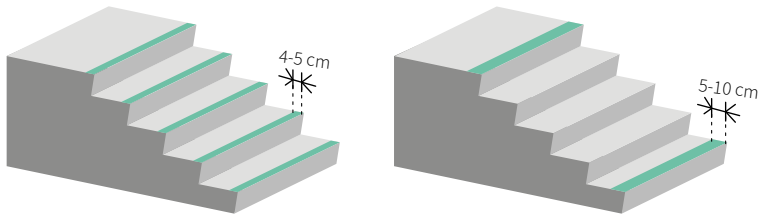

Two ways of marking the edges of stair steps.

It is important that the stripe is placed at least on the horizontal part of the step, so that it is visible when ascending and descending the stairs. It is possible to provide an additional band with a maximum width of 1 cm on the vertical part of the step. If the technical solution requires it, the stripe may be positioned max. 1.5 cm away from the edge of the step⁸⁰.

There are various options for this type of marking, e.g.:

- taping the staircase technology with relatively low durability and poor aesthetics;
- the use of steel or plastic angles a durable technology, used e.g. in railway stations and metro stations. Preferably the step should be cast in the right way or the edges should be notched so that the angle is flush with the rest of the step surface;
- grooves are milled into the surface of the step to allow the insertion of mouldings or the pouring of resin a technology that is long-lasting and allows aesthetic visual effects to be achieved.

The contrast of the markings in relation to the step surface must comply with the principles described in subchapter LRV (p. 54).

⁷⁹ ISO 21542:2021, clause 8.3.6.

⁸⁰ Ibid.

TACTILE MARKINGS

In areas with particularly high pedestrian traffic, e.g. at the stairs located on the access to the main entrance, as well as in other important places for users, it is important to supplement visual information with tactile markings.

ISO 21542:2021 indicates the need for a 60-90 cm wide tactile strip located 30-50 cm from the edge of the step⁸¹. Moving the warning signs away from the edge of the step allows the visually impaired person time to realise the position of the obstacle and make an appropriate decision.

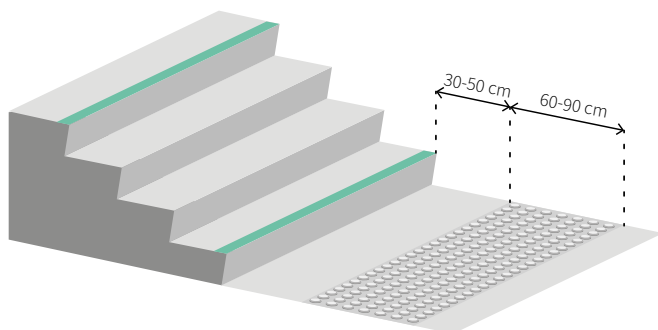

Position and width of tactile markings in front of stairs.

Detailed parameters for tactile markings are described in chapter B.7 (p. 67).

7.6. Escalators

From the point of view of a visually impaired person, two types of markings on escalators are important:

- contrasting stripes in front of, at the top and bottom of the stairs,
- contrasting stripes along the edge of each step.

⁸¹ ISO 21542:2021, clause 8.3.6.

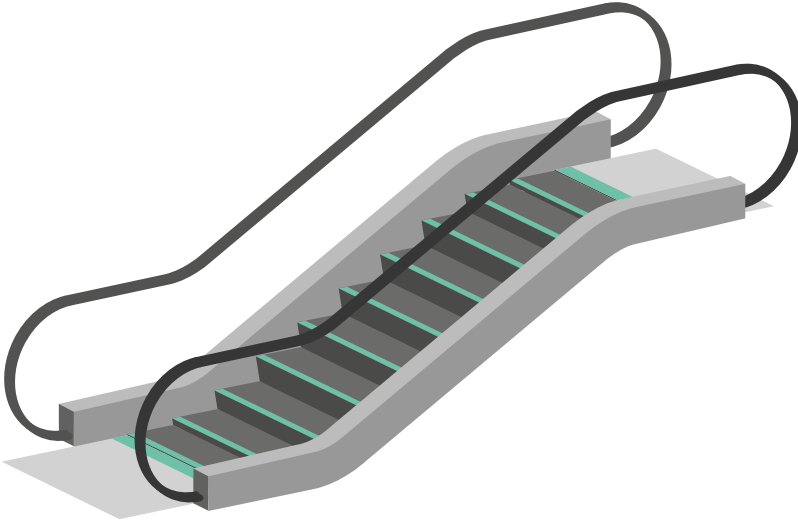

Contrast markings on escalators.

The contrast of this type of signage to the surface of the stairs should be in accordance with the principles described in subchapter LRV (p. 54).

Tactile markings are not necessary, as their role can be played by the metal plate preceding the flight of stairs.

IMPORTANT PARAMETERS

STEP PARAMETERS, FLIGHT LENGTHS, AND LANDINGS

Stair step height:

- for interiors and exteriors: max. 17.5 cm (recommended max. 15 cm),
- to garages: max. 19 cm (recommended max. 15 cm)..

Stair step width:

- internal and external: according to the formula $2h + s = 60-65$ cm,
- external at main entrance: min. 35 cm.

Recommended step profile: Slightly inclined riser, bottom edge retracted by max. 2.5 cm.

Not recommended step profiles: floating (without riser), with nosing.

Width of stair flight (measured between handrails):

- internal and external: min. 120 cm,
- to garages: min. 90 cm.

Maximum number of steps in flight:

- internal stairs: 17,
- external stairs: 10.

Minimum number of steps in flight: 3

Minimum length of the landing:

- internal and external: 150 cm,
- to garages: 90 cm.

Safe space to wait for the rescue team: provided in the staircase or in a room with direct access from the staircase, e.g. in the vestibule of a fire lift.

HANDRAILS

Stairs over 50 cm: handrails required on both sides, additional intermediate handrails required for stairs over 4 m wide.

Stairs less than 50 cm: at least one handrail recommended.

Railing height: 110 cm.

Height of additional recommended railing: 60-75 cm.

Gaps in railing: max. 20 cm.

Extension of the handrail beyond the flight of the stairs (on external stairs necessary, on internal stairs – recommended): min. 30 cm.

Distance of the handrail from the wall or other obstacle: min. 5 cm.

Handrail cross-section:

- variant 1: cross-section inscribed in two circles with diameters of 3.5-4.5 cm, rounded edges with a radius of min. 1.5 cm,
- variant 2: diagonal or diameter max. 5.7 cm, perimeter 10-16 cm.

Contrast of handrails to background: in accordance with subchapter LRV (p. 54).

SPACE UNDER THE STAIRS

Safety measures for spaces under stairs that can be entered, up to a height of at least 210 cm.

VISUAL AND TACTILE MARKINGS

Regulations

- Contrast markings along step edges.
- Markings on the landings in a strip of 30 cm from the starting and ending edges of the flight of stairs – change in colour shade or texture.

Zalecane

Visual

Variante 1: marking of the edges of all steps with 4-5 cm wide stripes.

Variante 2: marking of the edges of the first and the last step in each flight with 5-10 cm wide stripes.

Position of the stripe: at least on top of the step.

Allowable offset of the stripe from the front edge of the step: max. 1.5 cm.

Contrast of the marking to the colour of the steps: according to subchapter LRV (p. 54).

Tactile

Width of tactile strip: 60-90 cm.

Distance of the strip from the edge of the step: 30-50 cm.

Marking parameters: according to the information given in chapter B.7 (p. 57).

ESCALATORS

Contrast marking in front of the flight of stairs: at the top and bottom of the stairs.

Contrast marking of stair edges: along the edge of each step.





8

OFFICE SPACE

8 | OFFICE SPACE

8.1. Circulation space parameters

WIDTH OF CIRCULATION SPACES

The width of the most important circulation spaces, e.g. near the entrance to the office, must be min. 180 cm.

Corridors and the main circulation spaces near the desks in open spaces must be at least 150 cm wide.

Passages of secondary traffic importance, e.g. between desks, may be 120 cm wide. Local narrowings of up to 90 cm are also possible, but must not occur in areas requiring a change of traffic direction.

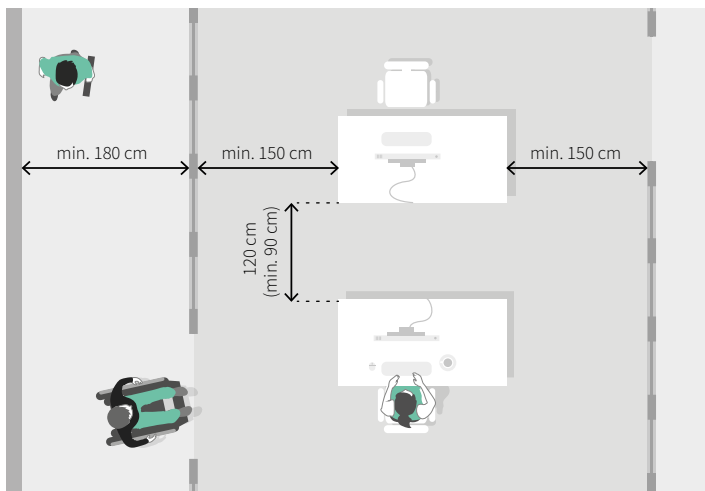

Width of circulation spaces according to their function.

HEIGHT OF CIRCULATION SPACES

The height of circulation spaces must not be less than 210 cm.

Only such a height ensures safety for different groups of people, including those with visual impairments.

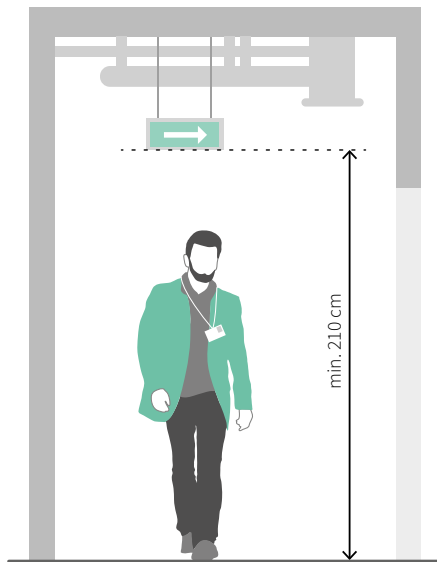

Minimum height of circulation space.

When designing hanging elements, e.g. display cases, visual information, the safety of visually impaired people must be taken into account. The parameters for these elements are outlined in chapter B.1 (p. 29).

CHANGES IN LEVELS

Within a single floor, design level changes should be avoided. If this is not possible for technical reasons, the aim should be to level them by means of ramps and only secondarily by means of technical equipment.

For more information on ramp parameters, see chapter B.3 (p. 36).

For more information on vertical transport equipment, see chapters B.2 (p. 35) and 6 (p. 142).

8.2. Reception areas

Reception areas in office spaces should be designed in accordance with the principles described for reception areas in the entrance halls of buildings – see chapter 5.2 (p. 133).

8.3. Doors

Doors in office spaces should be designed in accordance with the conditions set out in chapter B.4 (p. 38).

8.4. Workstations

We are observing clear changes in the way office spaces are designed and operated. An employee's attachment to a specific desk is changing in favour of choosing a desk each day and flexible working hours. These changes have been accelerated by the COVID-19 epidemic.

The lack of attachment to a specific office workstation makes it difficult to adequately accommodate people with special needs. Wheelchair users may need height-adjustable desks, special chairs will be necessary for people with back problems or hip transplants. For this reason, it seems that at least some people require a permanently allocated desk.

It is, of course, possible to try to design all desks as universally accessible, but this will involve increasing the distance between desks, providing desks with automatic height adjustment and limiting the height of common furniture, such as those with documents and office supplies.

It is essential to design the office as a flexible space that allows for changes and adaptation of the workstation to the needs of the individual.

MANOEUVRING SPACE

The manoeuvring space in front of the desk is an important factor in determining the accessibility of a given workstation. Its dimensions should be at least 150 x 150 cm, although in some situations it can be larger.

In open- space settings, it is advantageous to arrange the desks in such a way that the workers in successive rows sit facing each other alternately with their faces and backs. Such an arrangement naturally necessitates a wider space (even 180-200 cm) between rows of desks, which makes it easy to adapt the workstations to the needs of a wheelchair user.

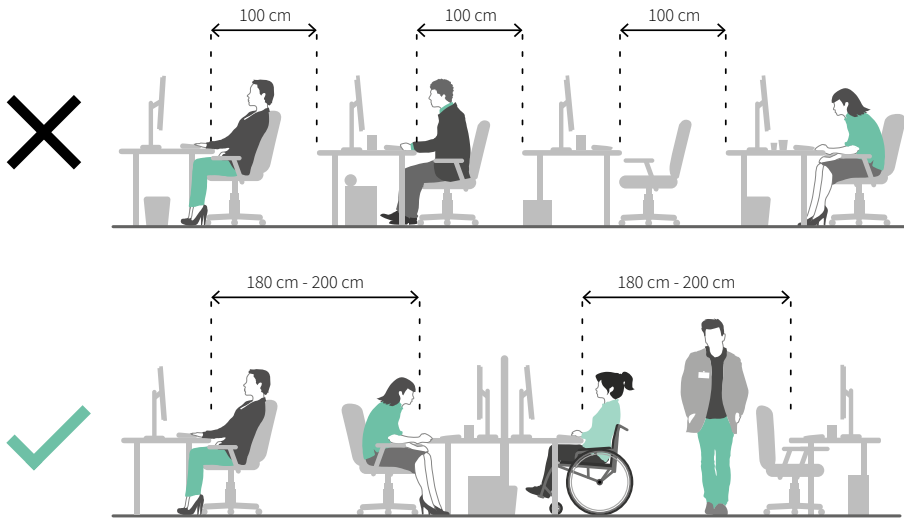

Width of aisles between desks. At the bottom, parameters that allow a wheelchair user to work.

In multi-person rooms, placing the desks facing the wall will usually allow more manoeuvring space in the middle of the room.

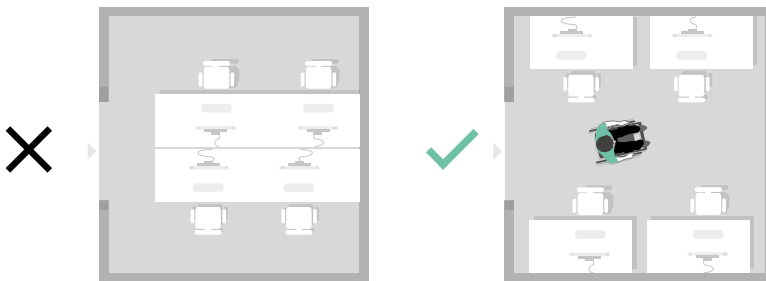

Principle of organising an office room in a way that allows a wheelchair user to work.

In single rooms, it is often necessary to position the desk facing the entrance in such a way that another employee or visitor can be comfortably received. In small rooms, it is difficult to provide adequate manoeuvring space for a visitor and employee at the same time. In such a situation, it is useful to consider alternative furnishing options:

- basic variant – with a desk facing the entrance and a manoeuvring space of min. 150 x 150 cm near the entrance;

- a variant of a workstation accessible to both the employee and the visitor – with the desk facing the wall and leaving a free space of at least 150 x 150 cm in the centre of the room. In this situation the manoeuvring space can be used by both the employee and the visitor.

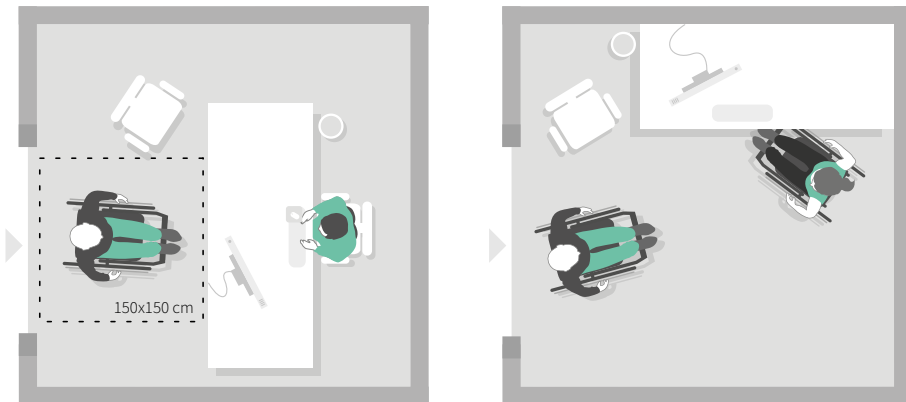

Principle of office room organisation. On the left, the ability to accommodate a guest with a disability. On the right, possibility to work and receive a visitor..

DESK PARAMETERS

Provision of free space under the desk of min. 70 cm, width min. 90 cm and a depth of min. 60 cm plus min. 20 cm of space with a height of min. 30 cm to accommodate feet, should allow people in different types of wheelchairs to work⁸². As with manoeuvring spaces, it is worth bearing in mind that the individual needs of each worker may vary.

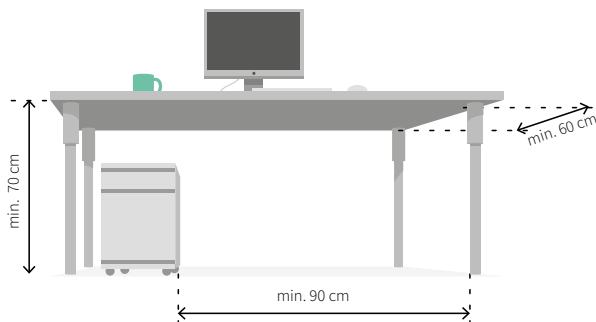

Wheelchair accessible desk parameters.

⁸² ISO 21542:2021, clause 9.3.3.

A wheelchair user cannot adjust the height of the seat, so height-adjustable desks are an important solution. It can also be helpful to plan cabinets on wheels that can be easily removed from under the desk, gaining additional space.

8.5. Meeting rooms

In meeting rooms it is necessary to provide a manoeuvring space of min. 150 x 150 cm. This space must not be restricted by the door opening area. The same space must be available at least at one table. The manoeuvring space may be used simultaneously to provide access to the door and the table.

The free space under the table should be no less than:

- height: 70 cm,
- width: 90 cm,
- depth: 60 cm.

All rooms intended for a minimum of a dozen people should be designed to be usable by wheelchair users. In the case of smaller rooms, at least one room in a particular part of the office must be adapted.

If the layout of the room can be changed, adequate space for a wheelchair user must be provided in each configuration.

In large meeting rooms, designed for dozens or hundreds of participants, wheelchair spaces must be provided in the number according to the table below⁸³.

Number of seats for people with disabilities in relation to the total number of people in the meeting room.

Total number of seats	Number of wheelchair accessible seats
0-50	min. 2
51-100	min. 3
100-200	min. 4
each additional 200 seats started	min. 1 additional seat

⁸³ ISO 21542:2021, clause 10.4.4.

The place intended for a wheelchair user must not be less than 90 x 140 cm, and the depth of the row in which such a place is located must not be less than 240 cm⁸⁴. In halls without fixed seats, such seats may be designated by not setting up chairs or by spacing the rows more widely.

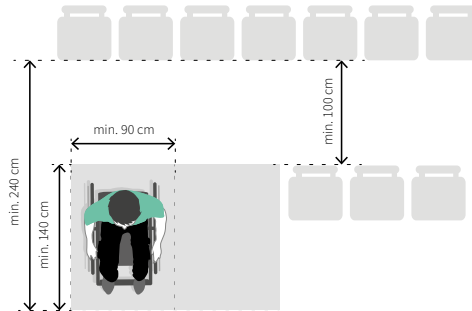

Size of place for a wheelchair user.

If an elevated podium is designed in the room, access to it must be accessible for wheelchair users, e.g. by means of a ramp or a vertical lift.

For the poor of hearing, it will be beneficial to equip large halls with a stationary induction loop. Installing this type of system involves connecting a special amplifier to the auditorium's sound system and extending a cable around the room or, in the case of large rooms, also under the room. The system is used to convert sound into an electromagnetic signal that can be picked up directly by hearing aids, once they have been switched to a mode for receiving this type of signal, the so-called 'T' mode.



Induction loop symbol.

⁸⁴ ISO 21542:2021, clause 10.4.4.

8.6. Social rooms – kitchens

In social rooms, wheelchair users need to maintain adequate manoeuvring spaces. A space of 150 x 150 cm should be located near the entrance (outside the door opening area), by the kitchen cabinets and near the table.

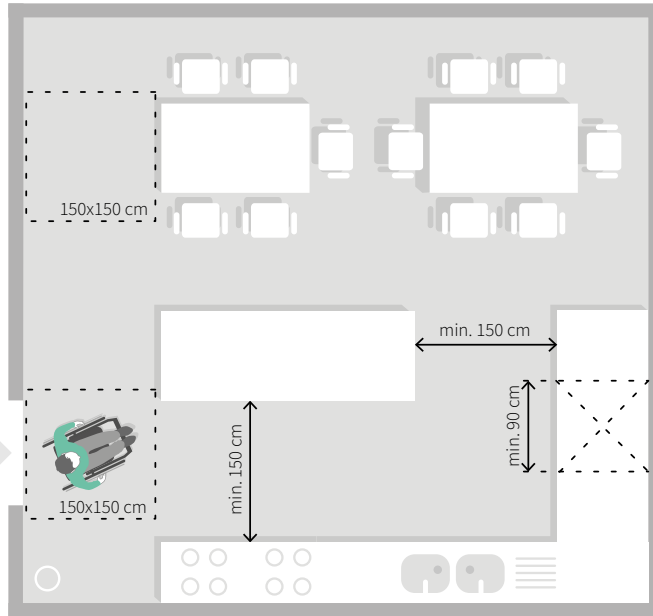

An example of an employee kitchen.

All essential appliances and equipment must be located within a height of 110 cm, this includes the microwave oven, coffee machine, towels, cutlery cabinets. The exception may be the refrigerator, which may only be partly within the indicated range. At least some of the cupboards should be under the worktop to allow the wheelchair user access to dishes and cutlery and to store their own products.

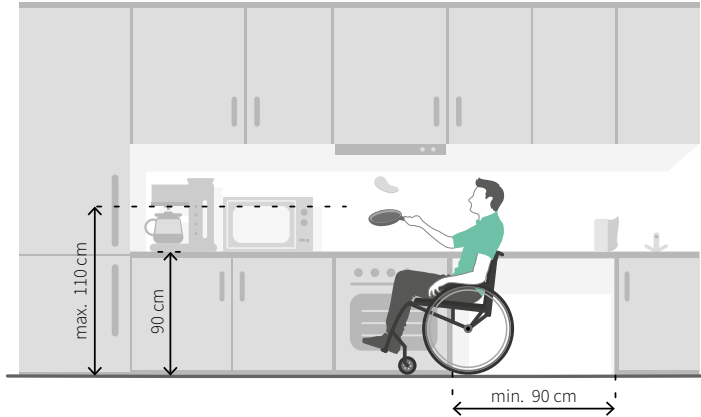

Kitchen cabinets and dimensions for placement of relevant equipment.

It is recommended to leave a section of the worktop without cabinets underneath. The width of such a space should not be less than 90 cm. This will make it easier for a wheelchair user to prepare their meal.

Tables must be selected in such a way that they can be used by a wheelchair user. The free space under the table top should have the following parameters:

- height: 70 cm,
- width: 90 cm,
- depth: 60 cm.

A slightly lower section of the worktop and the ability to automatically lower the upper cabinets can also be helpful.

IMPORTANT PARAMETERS

CIRCULATION SPACE PARAMETERS

Width of main circulation spaces: min. 180 cm.

Width of corridors and passageways near desks in open spaces: min. 150 cm.

Width of secondary circulation spaces: min. 120 cm.

Height of circulation spaces: min. 210 cm.

Hanging elements (display cabinets, visual information, etc.): to be placed according to the data given in chapter B.1 (p. 29).

Changes of level within a floor: to be avoided (for more information see chapter B.2, p. 34).

DOORS

In accordance with the parameters described in chapter B.4 (p. 38).

ACCESSIBLE WORKSTATION

A workstation for a person with reduced mobility requires individual adaptation.

The basic starting parameters are indicated below.

Maneuvering space in front of the desk: min. 150 x 150 cm.

Free space under the desk (height x width x depth): min. 70 cm x 90 cm x 60 cm.

Desk top: preferably with automatic height adjustment.

MEETING ROOMS

Small meeting rooms

Manoeuvring space at the entrance: min. 150 x 150 cm outside the door opening area.

Space at the table: min. 150 x 150 cm at least in one place.

Free space under the conference table top: according to the parameters of the workstation.

Large meeting rooms

Number of wheelchair accessible seats:

- min. 1% of the total number of seats,
- recommended:
 - 1-50 – min. 2 places,
 - 51-100 persons – min. 3 places,
 - 100-200 persons – min. 4 places,
 - each additional 200 seats commenced – min. 1 additional place.

Dimensions of the space for a wheelchair user: min. 90 x 140 cm.

Row depth with wheelchair place: min. 240 cm.

Elevated podium: wheelchair access required.

Systems for the hearing impaired: at least one room with induction loop.

SOCIAL ROOMS – KITCHENS

Manoeuvring space at the entrance: min. 150 x 150 cm outside the door opening area.

Maneuvering space at cabinets and at least one table: min. 150 x 150 cm.

Positioning height of essential equipment and appliances: max. 110 cm.

Cabinets: at least some at a height of up to 110 cm.

Countertop: recommended to leave min. 90 cm worktop width without cupboards underneath.

Free space under the table (height x width x depth): min. 70 cm x 90 cm x 60 cm.





9 | GASTRONOMY

9 | DINING AREA

9.1. Circulation space

In food service facilities, it is necessary to provide sufficiently wide circulation spaces between the entrance and the serving area, cash register, tables and dish return area.

In restaurants and other places with waiter service, such pathways must be designed between the entrance and the tables.

WIDTH OF CIRCULATION SPACE

The width of the most important circulation spaces, e.g. near the entrance, must be min. 180 cm.

Main aisles leading to the bar, tables and other important areas must be min. 150 cm. In areas with one-way traffic, e.g. along serving counters, this width may be reduced to 120 cm.

Aisles of secondary traffic importance, e.g. between tables, may be 120 cm wide, with permitted narrowing to 90 cm.

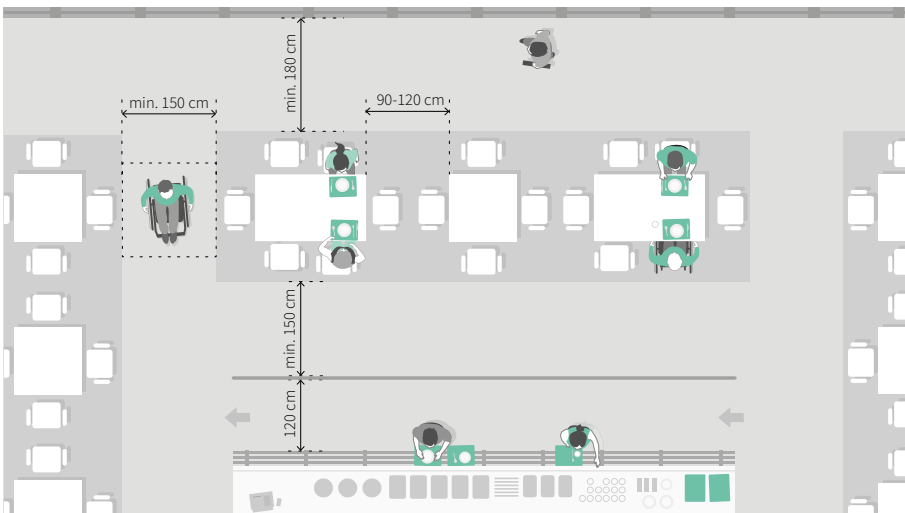

Minimum parameters for circulation space in the canteen

9.2. Bar and cash register

In self-service facilities, the bar and cash register must be at a height of no more than 90 cm. Dishes, cutlery and products that customers need to reach should be at a height of 80-110 cm. Some products may be placed higher, provided that they are also accessible at a lower height.

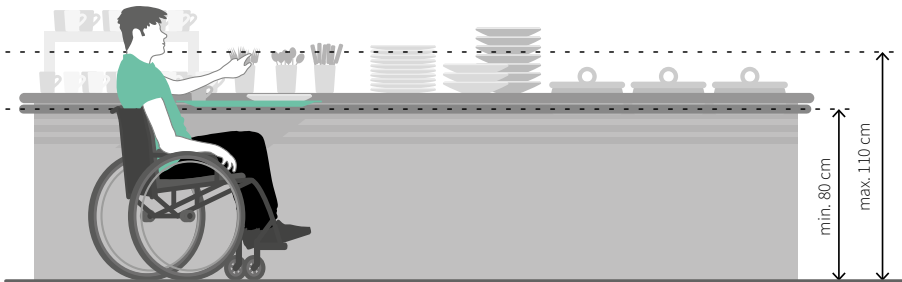

Principle of placing dishes, cutlery and other essential products.

It is not necessary to observe the parameters described above if waiter service is provided.

9.3. Tables

At least 25% of the tables should be wheelchair accessible⁸⁵.

A wheelchair accessible table should meet the following conditions:

- at least one side of it must have a clear manoeuvring space of 150 x 150 cm,
- the top of the table should be at a height of 72-75 cm,
- there should be free space under the table of min. 70 cm, width min. 90 cm and a depth of min. 60 cm.

Exceptions to the above rules are permitted for tables used in cafeterias.

⁸⁵ ISO 21542:2021, clause 10.11.

IMPORTANT PARAMETERS

CIRCULATION SPACE PARAMETERS

Width of main circulation spaces, e.g. near the entrance: min. 180 cm.

Passages between tables, access to the bar etc.: min. 150 cm.

One-way traffic, e.g. serving areas, space between tables: min. 120 cm.

BAR AND CASH REGISTER

For self-service, height of bar and cash register: max. 90 cm (at least 90 cm wide).

At self-service position of dishes, cutlery, essential products: 80-110 cm.

TABLES

Number of tables accessible to persons with mobility disabilities: min. 25% of the total number of tables.

Maneuvering space in front of the table accessible to persons with disabilities: min. 150 x 150 cm.

Table top height: 72-75 cm.

Space under the table (height x width x depth): min. 70 x 90 x 60 cm.





10 | SANITARY ROOMS

10

HYGIENE AND SANITATION FACILITIES

10.1. Location and allocation of toilets

PLANNING OF TOILETS IN A BUILDING

The rules for the location of toilets are governed by the Regulation on technical conditions to be met by buildings and their location. According to it, a toilet may not be located further than 75 m from a workstation or a place where people are present⁸⁶. In addition, at least one accessible toilet must be provided on each accessible floor where public toilets are designed⁸⁷. Public toilets are toilets located in the common areas of a building, but also toilets located in the office area, accessible to all employees.

If it is necessary to provide several sets of toilets on one floor because of the large floor area, it will be advantageous to design a toilet for people with disabilities in each of them.

DIVISION OF TOILETS FOR PEOPLE WITH DISABILITIES

Toilets for people with disabilities can be designed in several ways. The advantages and disadvantages of the different ways of designing toilets are shown in the table below.

⁸⁶ Regulation of the Minister for Infrastructure on the technical conditions to be met by buildings and their location, § 84(3).

⁸⁷ Ibid, § 86(1).

Advantages and disadvantages of different ways of designing toilets for people with disabilities

The design of toilets for persons with disabilities	Advantages	Disadvantages
<p>One toilet for people with and without disabilities. SMALL BUILDINGS ONLY</p>	<p>Space-saving.</p>	<p>A person with a disability may have to wait in a queue.</p>
<p>Toilet for people with disabilities independent of other toilets.</p>	<p>No queue to access the toilet. Possibility to enter the toilet with an attendant of the other sex. Possibility to design a toilet entrance without a vestibule – fewer doors to open.</p>	<p>Some people with disabilities take a negative view of such a division – describing such toilets as being for the ‘third sex’.</p>
<p>Adapted cubicles separately in men's and women's toilets.</p>	<p>No queue access to toilets. No issue of creating toilets for the so-called ‘third sex’.</p>	<p>Uncomfortable use of the toilet when assistance from an assistant of the other sex is required. Entrance with vestibule – need to open more doors.</p>
<p>Combining a toilet for people with disabilities with a unisex toilet (usually the women's toilet). SOLUTION NOT RECOMMENDED</p>	<p>Space-saving.</p>	<p>A person with a disability may have to wait in a queue. People with disabilities feel uncomfortable when they have to use a toilet intended for the opposite sex.</p>

10.2. Entrance to the toilet for people with disabilities

VESTIBULE

The regulations allow for no vestibule in front of the toilet for people with a vestibule disability⁸⁸, which saves space in the building while making it easier for wheelchair users to get to the toilet.

When a vestibule is designed in front of a toilet for people with disabilities, its parameters must be suitable for a wheelchair user – in accordance with chapter 4.4 (p. 123).

A common mistake made when designing toilet vestibules for people with disabilities is not considering the door opening area, which limits the manoeuvring space.

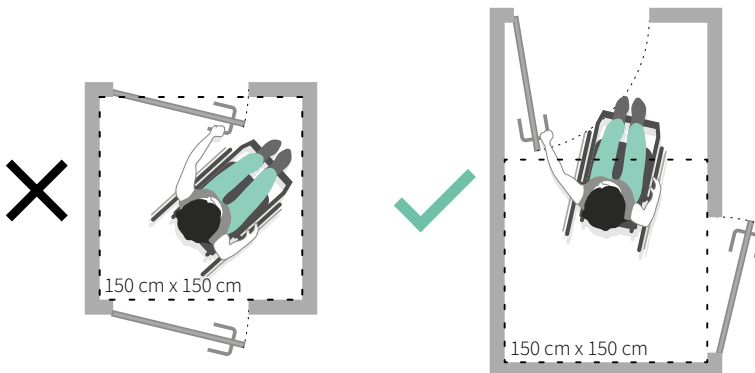

Minimum vestibule parameters

DOOR PARAMETERS

The width of the door leading to the toilet for persons with disabilities must not be less than 90 cm. These doors must not have thresholds.

In addition to the usual handle, it is good practice to design a horizontal railing on both sides of the leaf to facilitate door opening.

⁸⁸ Ibid, § 86(2)

Toilet doors are usually fitted with door closers. In order for a person with a mobility impairment to be able to enter the room freely, the door closer must not put up too much resistance. The force required to open the door should not exceed 25 N⁸⁹.

It is advantageous to use door closers with a closing delay to allow the user time to enter the toilet comfortably.

Lock

For people with manual disabilities, the shape of the handle of the lock, allowing the toilet to be locked from the inside, is of great importance. Locks with a handle that is flat and as wide as possible or shaped like a small handle are advantageous.

Cylindrical handles or handles that are too small to grip comfortably are unacceptable.

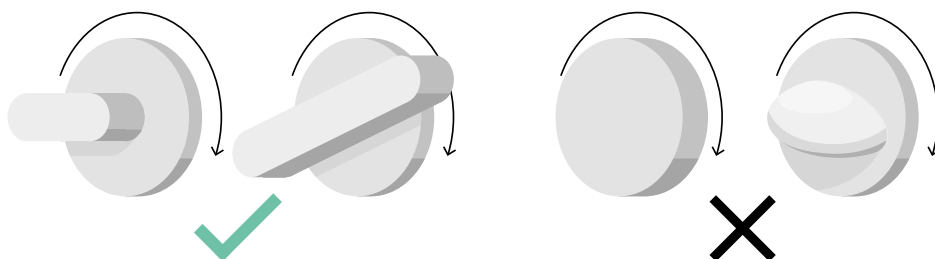

Different types of handles in door locks.

LIGHT SWITCHES

To ensure that people with different needs are able to switch on the light in the toilet, the following solutions can be used:

- light switches placed at a height of 80-110 cm, at a distance of at least 60 cm from the corner of the walls,
- lighting activated by a movement or presence sensor – a presence sensor is preferable because the light does not go out even if the person using the toilet remains motionless for a long time (the device is more sensitive),
- permanent lighting, e.g. controlled by BMS.

⁸⁹ ISO 21542:2021, pkt 9.1.1.3.

10.3. Manoeuvring space in the toilet for people with disabilities

According to Polish regulations, a toilet for people with disabilities must have a suitable toilet bowl, washbasin and handrails, but their parameters are not specified. Only the dimensions of the manoeuvring area are precisely defined, min. 150 x 150 cm⁹⁰. Note that this field must be square and not circular.

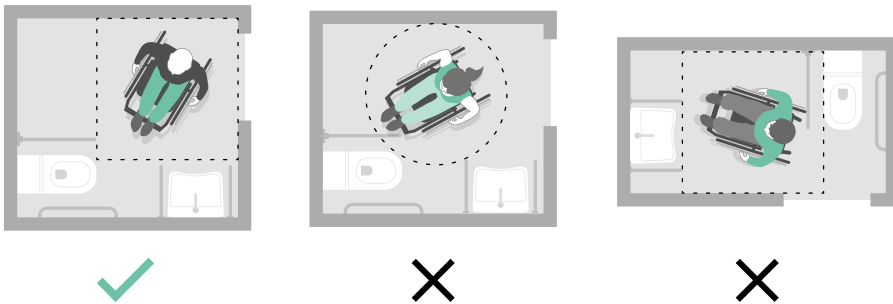

Principle for designating the manoeuvring area in a toilet for people with disabilities. On the left, a square field – designated correctly; in the middle, a circular field – designated incorrectly; on the right, a manoeuvring field designated correctly, but the position of the bowl seriously impeding access to the door.

For the wheelchair user, other parameters of the toilet and its equipment are also important, including the correct placement of the bowl and the washbasin.

In front of the wash basin there should be a free space of min. 80 x 125 cm, to enable the wheelchair to be positioned comfortably⁹¹.

Space should be provided around the toilet bowl to allow various types of transfer between wheelchair and bowl. In front of the bowl this space should have a length of min. 150 cm, while on at least one side of the bowl its width must not be less than 90 cm. Widening the space next to the bowl from 90 to 120 cm will increase the number of wheelchair users who will be able to transfer from wheelchair to bowl from 65% to 90%⁹².

⁹⁰ Regulation of the Minister for Infrastructure on the technical conditions to be met by buildings and their location, § 86(1).

⁹¹ ISO 21542:2021, clause 10.5.3.2-4.

⁹² Ibid, clause 10.5.3.1.

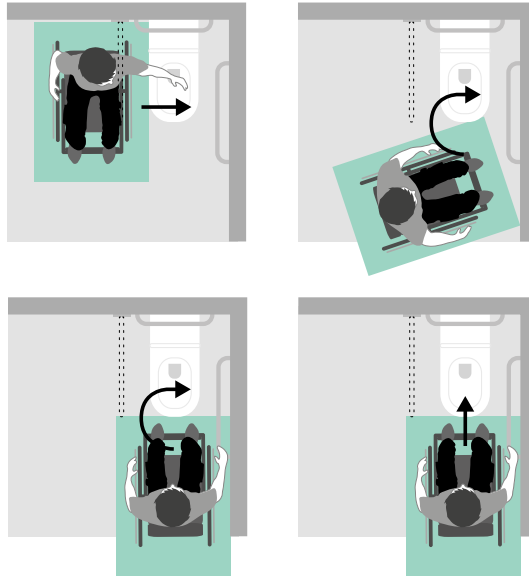

Different ways to transfer from wheelchair to toilet bowl. The grey rectangle indicates the 90 x 130 cm space required to position the wheelchair. At the top, side transfer and diagonal transfer – ways requiring the least amount of force. Bottom two types of front transfer – ways that require a lot of dexterity and strength. The transfer shown on the bottom right is described in the literature, but is used very rarely in practice.

Disabilities may affect the left or right side of the body to varying degrees, so if the available space allows, it is advantageous to design the room in such a way that both sides of the bowl have a minimum clear space of 90 cm. If this is not possible, and several toilets are planned in the building, it is advantageous to provide the free space alternately – on the left and on the right side of the bowl.

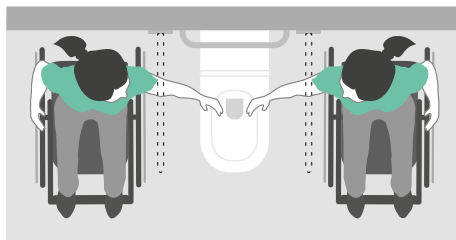

Space on both sides of the bowl to allow the person with a disability to choose the transfer method that is more comfortable for them.

Examples of toilet designs for people with disabilities can be found in ISO 21542:2021.

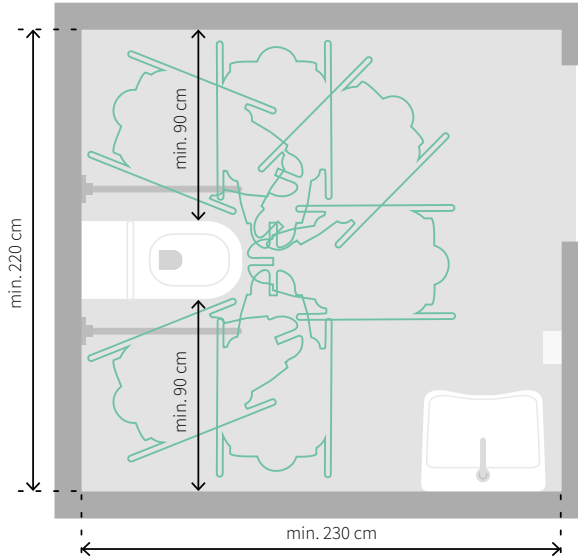

Variant 1 – example layout of a large toilet with wheelchair transfers provided from both sides of the bowl. Prepared on the basis of ISO 21542:2021.

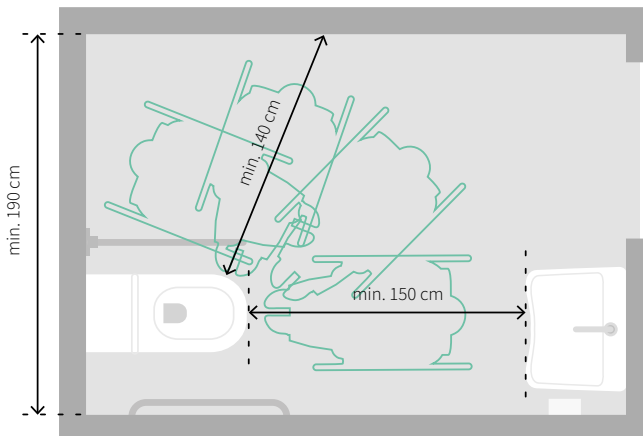

Variant 2 – example layout of a standard toilet with transfer provided from one side of the bowl. Prepared on the basis of ISO 21542:2021.

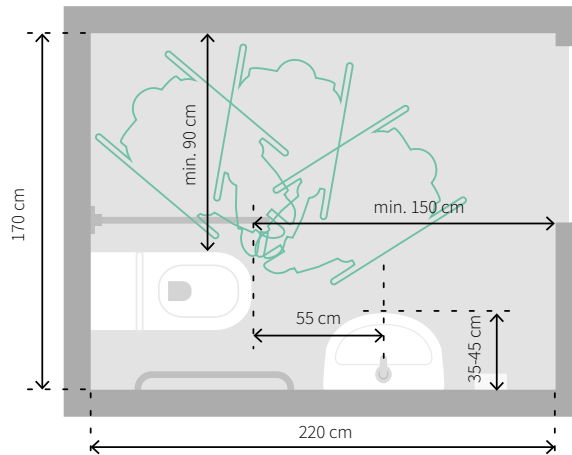

Variant 3 – example of a small toilet layout. The manoeuvring space is partly under the washbasin. In this case, it is necessary to use a small washbasin. This layout can only be designed in existing buildings if the amount of space available does not allow a larger toilet to be designed. Prepared on the basis of ISO 21542:2021.

10.4. Toilet fittings for people with disabilities

TOILET BOWL

The usability of a bowl is determined primarily by two parameters – its length and the height at which the top edge is located. A correctly selected unit must be 65-80 cm long⁹³. Maintaining this dimension is particularly important for side transfers, when the wheels and handles push the wheelchair seat away from the wall.

The top edge of the bowl should be at a height of 45-48 cm. The ISO 21542:2021 standard pushes the lower limit to 40 cm. Such a height, on the one hand, is advantageous for people of low height, but on the other hand, it can seriously impede the return from the bowl to the wheelchair and is therefore not recommended.

Appropriate performance is most easily achieved with bowls designed for people with disabilities, but other solutions are also possible in technically challenging situations. Examples are shown in the figure below.

⁹³ ISO 21542:2021, clause 10.5.5.

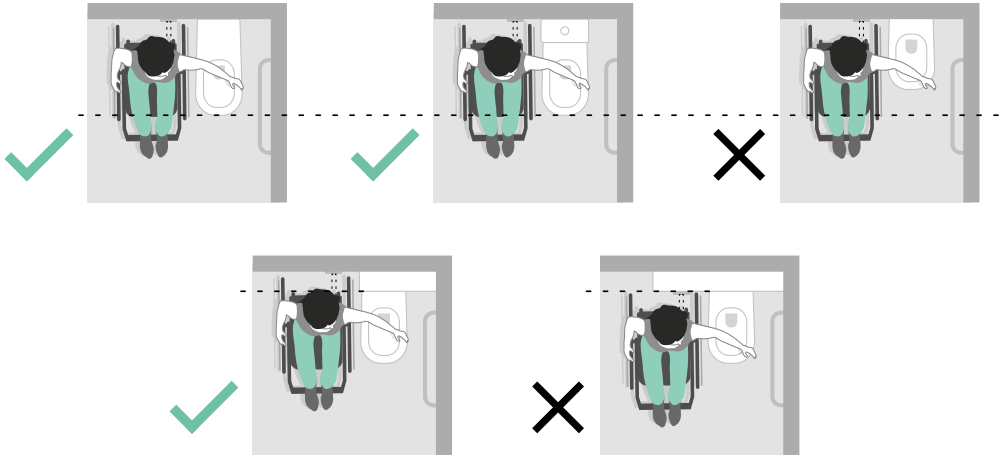

Different ways of ensuring the correct bowl length. At the top, an suspended bowl and a compact 65-80 cm long bowl, and a bowl that is too short and makes it difficult to transfer. Bottom left, short suspended bowl – the correct length has been ensured by the proper design of the flush cistern installation. Bottom right: short suspended bowl with incorrectly designed flush cistern installation.

The toilet bowl should be designed at a distance of min. 45 cm from the nearest wall. The handrails must be at a distance of 30-35 cm, from the axis of the handrail to the axis of the bowl⁹⁴. When the axis of the bowl is 45 cm from the wall, the handrail attached to the side wall may be at a slightly greater distance. The handrail on the free space side must be hinged. If transfer is possible from both sides of the bowl, both handrails must be liftable.

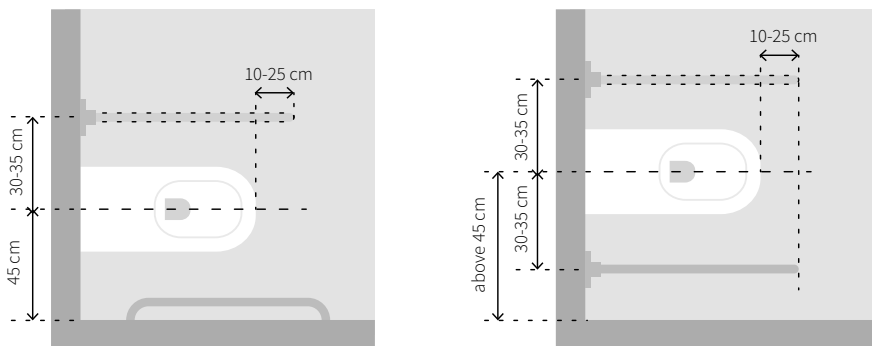

Principle of handrail design at the toilet bowl depending on the distance between the bowl and the wall.

⁹⁴ ISO 21542:2021, clause 10.5.6.

The following figure shows the parameters of a handrail fixed to the wall in accordance with ISO 21542:2021.

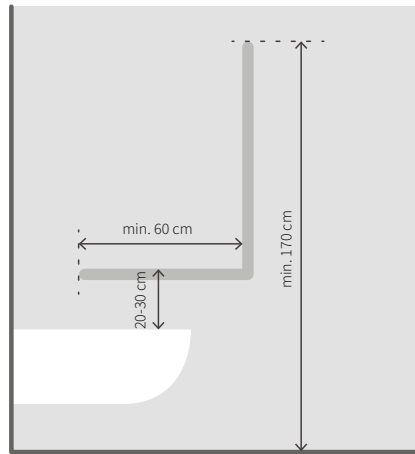

Wall-mounted handrail in conformity with ISO 21542:2021.

It is also important to fix the handrail correctly to the wall. The handrail must be able to transfer the dynamic loads from the person transferring from the wheelchair to the toilet bowl, which is why, for example, in the case of walls made of plasterboard, it is necessary to install racks in the wall to ensure the handrail is stable.

TOILET PAPER HOLDER

The toilet paper holder should be placed close to the front edge of the toilet bowl so that the person using the toilet does not have to reach backwards – in the case of persons with impaired mobility, it may not be possible to turn the body. If the axis of the bowl is more than 50 cm from the nearest wall, the paper should be placed on a special holder installed in the front of the handrail.

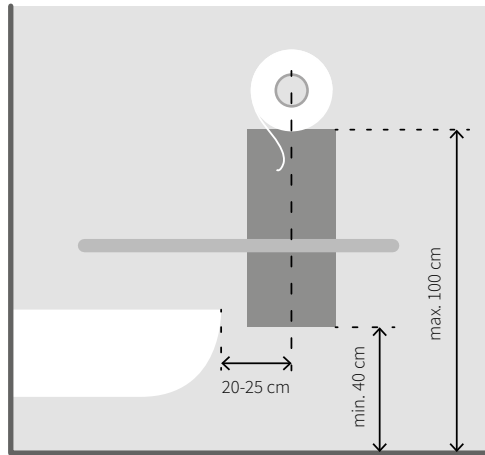

Example of toilet paper holder installation location. Compiled from ADA, Standards for Accessible Design⁹⁵.

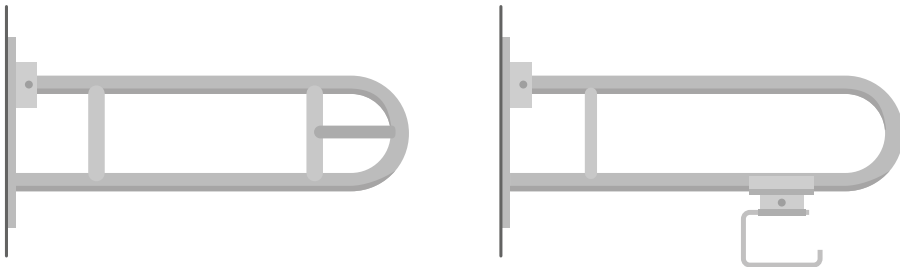

Examples of handrail-mounted paper holders.

WASHBASIN

The top edge of the washbasin must be at a height of 82-85 cm⁹⁶. Mounting close to the top limit will allow more space under the washbasin, which will be beneficial for tall people or people using large wheelchairs. A washbasin placed lower will be more comfortable for people of low height or those using a wheelchair with a low seat.

⁹⁵ In the figure, the upper limit of the holder position has been reduced from 120 cm to 100 cm. The upper parameters given in ADA, Standards for Accessible Design do not take into account the needs of people with limited upper limb reach. ISO 21542:2021 states that the bottom of the toilet paper container should be between 60 cm and 70 cm. This placement of the holder may not be possible due to a collision between the handrail and the holder.

⁹⁶ ISO 21542:2021, clause 10.5.8.

At the same time, the space under the washbasin must not be less than 65-70 cm. Cabinets or instantaneous water heaters must not be placed under the washbasin. The washbasin must also not be placed on a pedestal or half pedestal, as a person in a wheelchair will not be able to use it. It is good practice to install a concealed siphon, which takes up less space.

The depth of the washbasin must be between 45-60 cm, so that the wheelchair user can fit their knees under the unit⁹⁷.

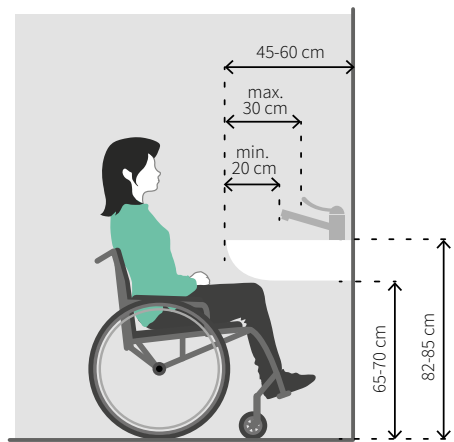

Washbasin parameters. Own elaboration based on ISO 21542:2021.

All the requirements for washbasins are met by washbasins designed for people with disabilities, but it is also possible to choose an ordinary washbasin accordingly.

For people with upper limb disabilities, the correct choice of tap is also important. Taps operated by a lever or a photocell are acceptable. In both cases, the distance of the lever or sensor from the front edge of the washbasin must not be greater than 30 cm, and the distance of the tap from the same edge must not be less than 20 cm⁹⁸. This can be achieved, among other things, by using taps with an extended lever.

In contrast, a knob-operated tap must not be installed as it may not be possible for a person with an upper limb disability to use it.

⁹⁷ ISO 21542:2021, clause 10.5.8.

⁹⁸ Ibid.

For people who use crutches, a cane or other orthopaedic aids, it will be helpful to install a handrail at the washbasin. The handrails should meet the following conditions:

- distance of the axis of the handrail from the axis of the washbasin: min. 40 cm, but no closer than 5 cm between handrail edge and washbasin,
- top edge of handrail at height of upper edge of washbasin,
- the front edge of the handrail extends at least as far as the front edge of the washbasin; handrails extending 10 cm to 25 cm beyond the edge of the washbasin are recommended. When using a longer handrail, make sure that it does not restrict the manoeuvring space in the toilet.

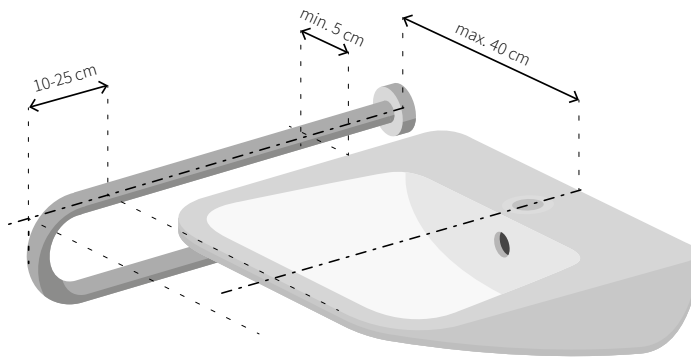

Arrangement of handrails at the washbasin.

SOAP DISPENSERS, DRYERS AND TOWEL HOLDERS

A soap dispenser and a hand dryer or towel holder must be placed near the washbasin. Both devices must be within reach of the person using the washbasin, and their lower edge must not be higher than 110 cm.

The soap dispenser should be touchless or have a large button on the bottom of the dispenser so that it can be operated with one hand.

MIRROR

The mirror at the washbasin can be hung in two ways:

- fixed – with the lower edge not higher than 90 cm and the upper edge not lower than 190 cm⁹⁹,
- tiltable – with an adjustment handle placed no higher than 100 cm. In this situation, the mirror's incline adjustment should allow a person sitting in a wheelchair and a person standing to see themselves.

⁹⁹ Ibid.

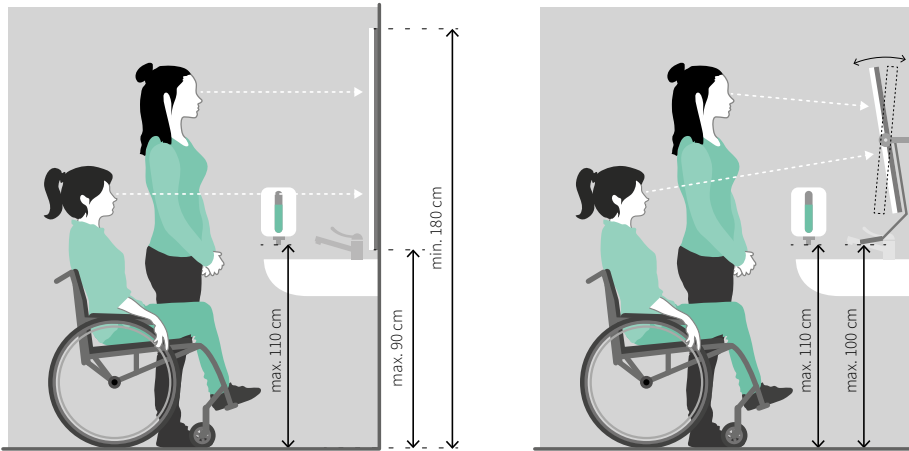

Two types of mirror. On the left, fixed mirror. On the right, a tilting one.

Hooks

If hooks are provided in the toilet, at least one of them must be within reach of the wheelchair user, at a height of 100-110 cm from the floor.

EMERGENCY CALL SYSTEM

There is an increased risk of falling in the toilet, for example when transferring from the wheelchair to the toilet bowl. There may also be difficulties getting back into the wheelchair. An emergency call system is useful in such situations.

For a system of this type to work properly, it is essential that the installation is properly designed.

Two ways of activating the alarm are commonly used:

- with pushbuttons – in this situation it is necessary to provide at least two pushbuttons at a height of 0-40 cm and 80-110 cm,
- by means of a rope – the rope should be no higher than 10 cm above the floor and reach to a height of at least 180 cm.

If there is an alarm cancel button in the toilet, it should be placed at a height of 80-110 cm.

All buttons or a rope to operate the system must be located in areas accessible from the wheelchair, so they should not be placed, e.g. closer than 60 cm from the corner of the room or hidden behind the toilet bowl. The buttons or cord to activate the alarm must be close to the toilet bowl.

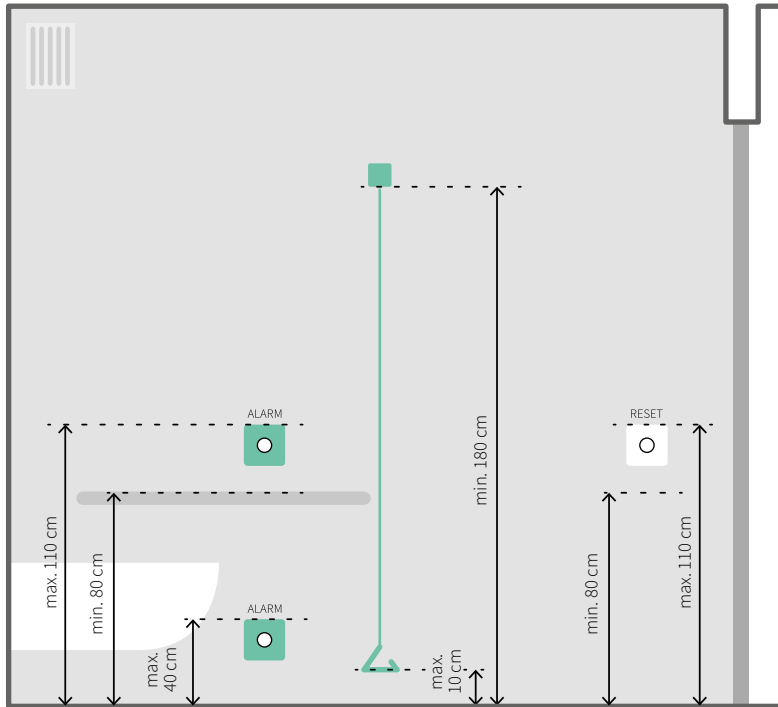

Design principle of the emergency call system. Acceptable push-button or rope actuation. Reset button positioned elsewhere so as not to be confused with alarm activation button.

The reception of the alarm should be confirmed by a visual signal as well as an audible one, and the alarm signal must be transmitted directly to the person responsible for providing assistance. A visual signal placed outside the toilet without transmission of the alarm, e.g. to security personnel, is most likely to be ignored by other building users.

10.5. Other toilets

ADAPTATION OF TOILETS TO MEET CHILDREN'S NEEDS

In buildings where a large number of children can be expected, e.g. a kindergarten, at least one public toilet should be suitable for the height of the children. In men's and women's toilets, this can be ensured by:

- at least one toilet bowl located at a lower height – the cubicle with such a bowl should be clearly marked,
- placing at least one urinal at a lower height (in men's toilets only),
- placing at least one washbasin at a lower height.

Other items, including a mirror, should also be located appropriately lower, e.g. toilet paper holder, soap dispenser, hand dryer or towel holder.

The installation height of the individual devices will then depend on the age of the children.

CUBICLES FOR THE ELDERLY AND PEOPLE WHO USE CRUTCHES, A CANE OR OTHER ORTHOPAEDIC EQUIPMENT

It is good practice to provide cubicles in public toilets that are adapted to the needs of the elderly and people with mobility impairments who use crutches or a cane, for example.

The width of such a cubicle should be min. 90 cm and the space in front of the bowl shall be not less than 90 cm¹⁰⁰. Along the sides of the cubicle, on both sides of the bowl, handrails shall be provided to facilitate getting up and sitting down.

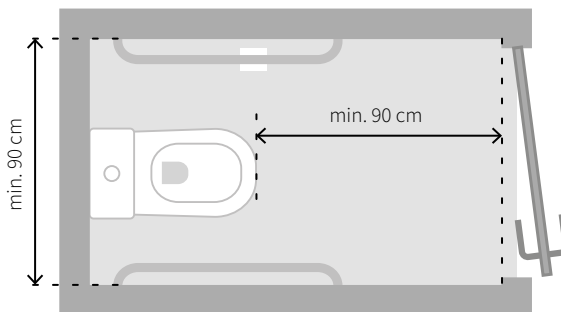

Parameters of a toilet cubicle adapted to the needs of the elderly and people with mobility impairments who use crutches, canes or other orthopaedic aids.

OPERATION OF APPLIANCES BY THE ELDERLY

The elderly may find it difficult to use automatic appliances or those controlled in various unusual ways. Hidden taps, soap dispensers and dryers, for example behind mirrors, can be particularly problematic. These are best avoided. And if they are necessary, ensure that the function is appropriately labelled.

¹⁰⁰ ISO 21542:2021, clause. 10.5.2.



Clear indication of the function and location of the appliances when hidden behind a mirror, in a wall, etc.

It is also good practice to install several types of appliance at the same time, e.g. a photocell-operated dryer and a towel holder, so that the user can choose which appliance is easier for them to use.

10.6. Parent-child rooms

In catering, retail or service buildings with a floor area of more than 1,000 m² and petrol stations with a floor area of more than 100 m², a parent-child room shall be provided¹⁰¹.

These rooms should also be adapted to the needs of wheelchair users by providing a manoeuvring space of min. 150 x 150 cm and convenient access to appliances.

Parent-child rooms should be designed so that they can be used by mothers or fathers with their child. It is bad practice to provide a changing table only in the ladies' room.

The changing table should meet the following conditions:

- be at a height of 80-85 cm measured to the top of the changing unit,
- have a clear floor space of at least 70 cm under the entire changing surface,
- have dimensions of not at least 50 x 70 cm,
- have safeguards to prevent the child slipping off,
- be made of a soft material,
- be without sharp edges.

¹⁰¹ Regulation of the Minister of Infrastructure on the technical conditions to be met by buildings and their location, § 85a.

In parent-child rooms, several solutions can be introduced to increase the comfort of the parents:

- a feeding area in a separate space, e.g. behind a curtain or an extra door. In this way, feeding the baby does not block others from using the changing table.
- washbasins at different heights, suitable for the child and the parent.
- toilet cubicles for the child and parent.

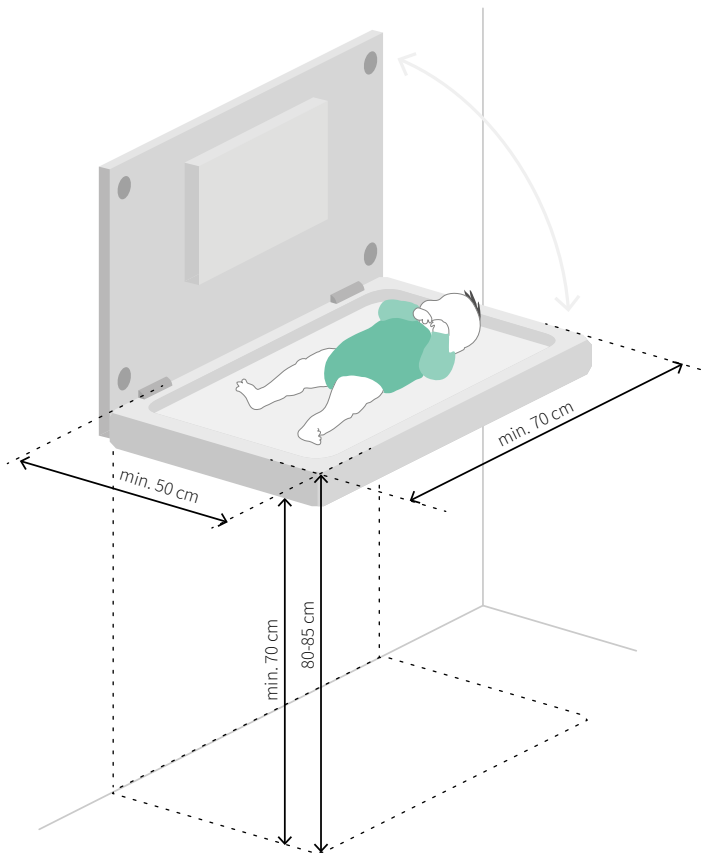

Changing table parameters.

10.7. Showers

In office buildings, showers are most often designed in cycling locker rooms, less often in other public spaces or directly in office spaces.

It is good practice to provide a shower adapted to the needs of people with disabilities. This can be used, for example, by people using handbikes attached to a wheelchair.

Persons with disabilities may use the same cloakrooms as other users. In such a case, it is necessary to provide:

- circulation space with a width of not less than 120 cm,
- a manoeuvring space of at least 150 x 150 cm in areas requiring a change of direction or manoeuvring of the wheelchair, e.g. at selected lockers,
- at least some of the lockers located at a height of up to 110 cm in areas accessible to a wheelchair user,
- a toilet adapted to the needs of persons with disabilities,
- a shower adapted to the needs of persons with disabilities.

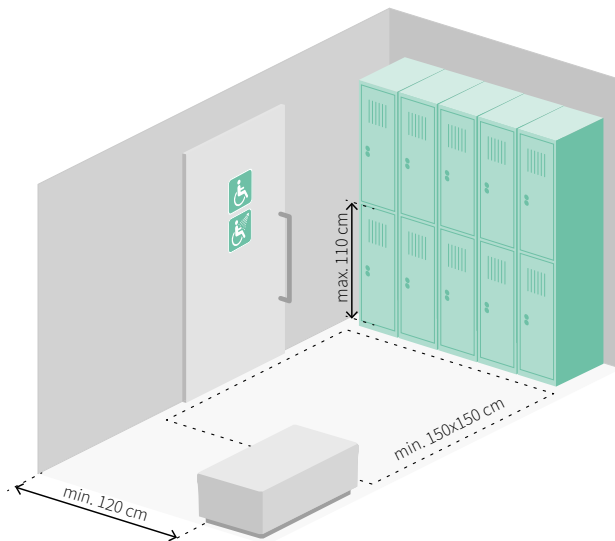

Example of a wheelchair-accessible cloakroom

When adapting a shower to the needs of a person with a disability, it is important to remember to provide:

- shower area with min. 90 x 130 cm – the shower tray must be free of thresholds, even in the case of a lockable cubicle,
- a free space next to the shower of at least 90 x 130 cm, placed parallel to the seat, and the way the cubicle opens must not make it difficult to transfer to the seat,

- a seat measuring at least 45 x 45 cm, placed at a height of 45-48 cm,
- a tap placed within reach of a person sitting on the seat, on a wall perpendicular to the wall on which the seat is installed, at a height of 90-110 cm,
- shower heads adjustable in height ranging from min. 100-180 cm,
- handrail (see figure below) – an L-shaped handrail may be used instead of a horizontal handrail¹⁰².

As people with spinal injuries may not feel the heat properly, the water temperature should be limited to prevent accidental burns.

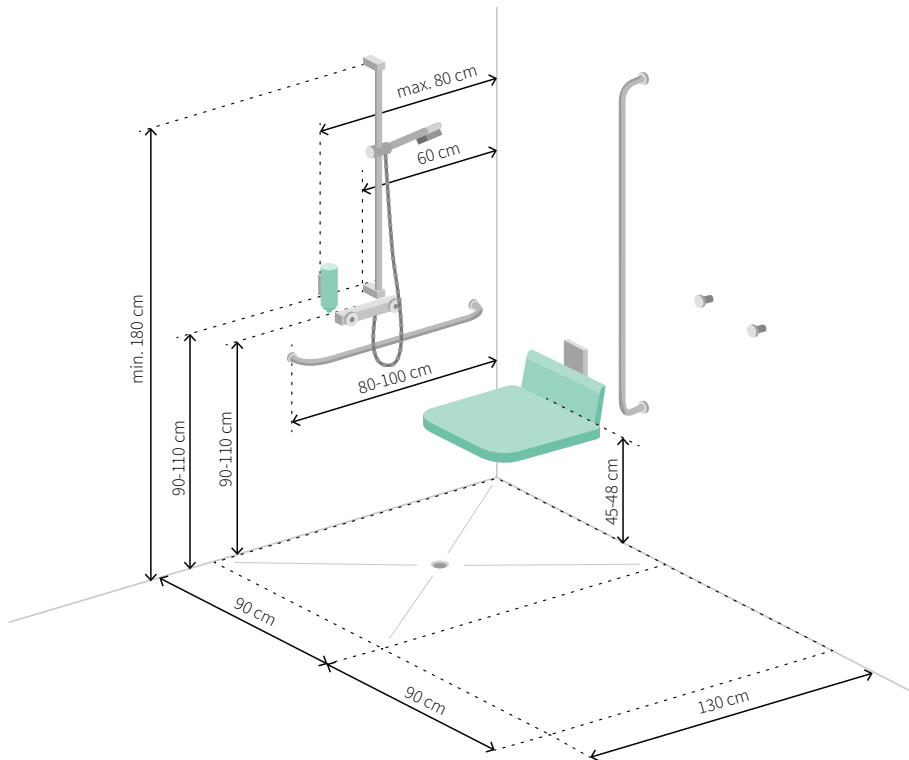

Example parameters of a shower adapted to the needs of a person with a disability. Prepared on the basis of ISO 21542:2021.

¹⁰² ISO 21542:2021 clause 10.5.15. The standard indicates that the seat should be positioned at a height of 40-48 cm. However, it should be mentioned that fixing the seat at a height lower than 45 cm can seriously impede the return to the wheelchair.

10.8. Changing places

Changing places are rooms designed for people who need urological treatment or to perform hygienic tasks.

According to an amendment to the Regulation of the Minister of Infrastructure on the technical conditions to be met by buildings and their location, from 1 April 2024, the provision of changing places will be necessary in buildings:

- public administration with a floor area over 2 000 m²,
- culture, sports, commerce, services or passenger services by rail, road or air with a floor area exceeding 10 000 m²,
- service stations with a floor area over 300 m² located on a motorway,
- healthcare regardless of the area¹⁰³.

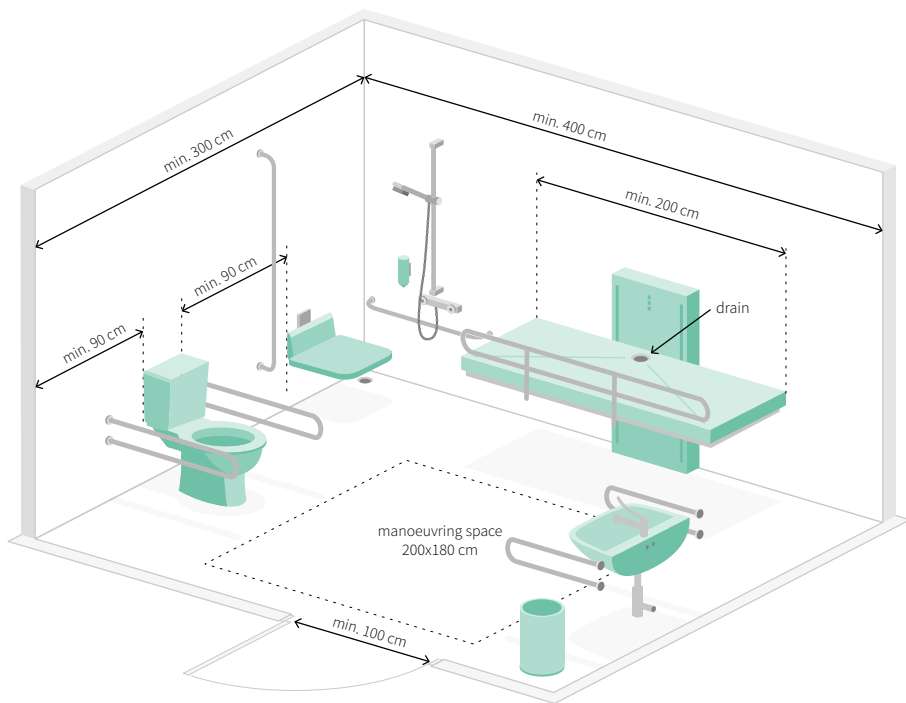

Example of a changing place.

¹⁰³ Regulation of the Minister for Development and Technology amending the Regulation on technical conditions to be met by buildings and their location, § 85a(2)..

The changing places will have to be designed on the floor where the entrance to the building is located, at a distance of no more than 20 m from that entrance¹⁰⁴. The amended regulation provides that a changing place may be combined with a toilet for persons with disabilities.

The area of the room will not be less than 12 m² and its width will not be less than 300 cm¹⁰⁵.

A well-designed changing place should be equipped with:

- a toilet bowl complying with the conditions described in chapter 10.4 (p. 219),
- a washbasin complying with the conditions described in chapter 10.4 (p. 219),
- bed for adults
- a lift to facilitate transfer between the wheelchair and other equipment in the room.

The couch should be at least 180 cm long and have a load capacity of at least 200 kg. It is good if it is also equipped with automatic height adjustment, folds against the wall and has a folding handrail to prevent falling.

We can divide the beds into those designed for wet rooms and dry rooms. The former offer the possibility of connecting to a sewer. A shower head is then installed next to it, and you can wash on the bed. The second type of bed is installed when it is not possible to connect a drain. Wet wipes and other hygiene products that do not require water are then used.

¹⁰⁴ Ibid, para. 3.

¹⁰⁵ Ibid.

IMPORTANT PARAMETERS

LOCATION AND ALLOCATION OF TOILETS

Distance from workplace to toilet: max. 75 m.

Location of toilets for persons with disabilities: on each floor where toilets are located (preferably in each toilet complex).

Recommended design principles for toilets for persons with disabilities:

- one toilet for people with and without disabilities – in small buildings only,
- a room independent of the men's and women's toilets,
- adapted cubicle in the men's and women's toilet complex.

ENTRANCE TO THE TOILET FOR PEOPLE WITH DISABILITIES

Vestibule: acceptable no vestibule.

Vestibule parameters: see information given in chapter 4.4 (p. 123).

Door width: min. 90 cm.

Handle: easy to operate for people with manual disabilities (additionally, it is recommended to install a horizontal handrail on both sides of the door).

Door opening force: max. 25 N.

Door closer: recommended door closer with closing delay.

Locking handle (inside the toilet): to allow operation by persons with upper limb disabilities.

Ways of activating the light:

- light switch: 80-110 cm, at a distance of min. 60 cm from the corner of the wall,
- motion or presence detector,
- permanent lighting, e.g. BMS-controlled.

MANOEUVRING SPACE IN THE TOILET FOR PEOPLE WITH DISABILITIES

Maneuvering area size: square area with min. 150 x 150 cm.

Obstacle-free space in front of the washbasin: min. 80 x 125 cm.

Width of clear space next to toilet bowl: min. 90 cm (120 cm recommended).

Transfer types provided from wheelchair to bowl: at least lateral and diagonal.

Design of clear space next to the bowl: at least on one side (both sides recommended).

TOILET BOWL IN A TOILET FOR PEOPLE WITH DISABILITIES

Bowl length: 65-80 cm.

Mounting height (measurement to top edge of bowl): 45-48 cm.

Distance of bowl axis from nearest wall: min. 45 cm.

Handrail distance (from the axis of the bowl to the axis of the handrail): 30-35 cm.

Tilting handrail: from the side where transfer from wheelchair to bowl is possible.

Position of the paper holder:

- axis of the bowl within 50 cm of the wall: on the wall next to the bowl,
- axis of the bowl more than 50 cm from the wall: handle in the front part of the handrail.

Mounting height of paper holder (to bottom edge): 40-100 cm.

Distance of the holder from the front edge of the bowl (measurement to the axis of the holder): 20-25 cm.

WASHBASIN IN A TOILET FOR PEOPLE WITH DISABILITIES

Position of the upper edge of the washbasin: 82-85 cm.

Free space under the washbasin: 65-70 cm.

Length of basin: 45-60 cm.

Type of tap: with lever (extended recommended) or photocell.

Distance of lever or photocell from the front edge of the washbasin: max. 30 cm.

Distance of spout from the front edge of the washbasin: min. 20 cm.

Handrails: on both sides of the washbasin.

Handrail distance (from the axis of the washbasin to the axis of the handrail): max. 40 cm (no closer than 5 cm between the sides of the handrail and the washbasin).

Handrail installation height: at the height of the top edge of the washbasin.

Length of the handrail: at least as far as the front edge of the washbasin (preferably 10-25 cm longer if it does not restrict the manoeuvring space).

OTHER APPLIANCES

Position of soap dispenser and towel dispenser/towel holder: within reach of a person at the washbasin.

Installation height of soap dispenser and towel dispenser/towel holder (up to the lower edge): max. 110 cm.

Soap dispenser operation: large button at the bottom of the container, one-handed operation.

Lower edge of fixed mirror: max. 90 cm.

Upper edge of fixed mirror: min. 190 cm.

Handle position in tilting mirror: max. 100 cm.

Range of adjustment of the tilting mirror: possibility to adjust the angle of incline to a person sitting on a wheelchair and standing.

Hook (if provided): at least one at a height of 100-110 cm.

EMERGENCY CALL SYSTEM

Acceptable methods of activation:

- buttons: min. 2 buttons placed at heights of 0-40 cm and 80-110 cm,
- rope: min. in height range 10-180 cm.

Alarm cancellation button (if designed): 80-110 cm.

Location of buttons/rope for activating the alarm: close to the bowl, in a place accessible also from the wheelchair, min. 60 cm from the corner of the walls.

Location of the alarm cancellation button: away from the bowl, in a place accessible from the wheelchair, min. 60 cm from the corner of the walls.

Signal reception information: audible and visual.

Signal transmission: to the person responsible for providing assistance (security, reception).

OTHER TOILETS

Toilets adapted to the height of children: in buildings where a large number of children can be expected, e.g. in a kindergarten.

Cubicles for the elderly and people on crutches / canes:

- width: min. 90 cm,
- length of space in front of bowl: min. 90 cm,
- handrails: on both sides of the cubicle.

Intuitive operation: clear labelling of appliance functions, provision of alternative solutions (e.g. photocell dryer and towel holder at the same time).

PARENT-CHILD ROOMS

Parent-child room in a restaurant, retail or service building with a floor area of more than 1,000m² and in a petrol station with a floor area of more than 100 m².

Maneuvering space: square min. 150 x 150 cm.

Parameters of a changing table:

- installation height (to top edge): 80-85 cm,
- free space underneath the changing table: min. 70 cm,
- dimensions: min. 50 x 70 cm,
- finishing: edges to prevent the child slipping off, soft finish material, no sharp edges.

SHOWERS

If showers are designed, it is recommended to provide showers that are accessible to people with disabilities.

Adapted shower in the public cloakroom

Width of circulation space in cloakroom: min. 120 cm.

Maneuvering spaces at diversion points and at selected lockers: min. 150 x 150 cm.

Location of lockers: at least some at a height of up to 110 cm, in areas accessible to a wheelchair user.

Toilet: at least one cubicle adapted to the needs of persons with disabilities.

Shower: at least one adapted to the needs of people with disabilities.

Shower adapted to the needs of people with disabilities

Shower area: min. 90 x 130 cm.

Shower tray: without threshold.

Cubicle: if designed, must not impede transfer from wheelchair to seat.

Free space next to the shower tray: min. 90 x 130 cm.

Seat dimensions: min. 45 x 45 cm.

Seat installation height (measurement to top of seat): 45-48 cm.

Position of the tap and shower head: on the wall perpendicular to the wall with the seat installed.

Height of the tap position: 100-110 cm.

Position of the shower head: height-adjustable in min. 100-180 cm.

Handrail: L-shaped, on the wall perpendicular to the wall with installed seat.

CHANGING PLACES

Application in buildings:

- public administration with a floor area of more than 2 000 m²,
- culture, sports, commerce, services or passenger services by rail, road or air with a floor area in excess of 10 000 m²,
- service stations with a floor area over 300m² located on a motorway,
- healthcare regardless of the area.

Location: on the floor where the entrance is located, within 20 m of the entrance.

Dimensions: min. 12 m² and width min. 300 cm.

Equipment:

- toilet and washbasin according to chapter 10.4 (p. 219),
- bed with automatic height adjustment and drain connected to a sewer,
- tap with shower head next to the bed,
- lift for easy transfer between wheelchair and changing place equipment.

Bibliography

Americans with Disabilities Act. Standards for Accessible Design, Department of Justice, USA 2010.

Budny J., *Dostosowanie budynków użyteczności publicznej – teoria i narzędzia*, Friends of Integration Association, Warsaw 2009.

Building for Everyone. Inclusion, Access and Use, National Disability Authority, Dublin 2002.

Czarnecki B., Siemiński W., *Kształtowanie bezpiecznej przestrzeni publicznej*, Warsaw 2004.

Duffy Maureen A., *Assessment and modification of the environment for visually impaired people*, „Zeszyty Tyflograficzne” no 20, Warsaw 2002 (transl. M. Kamionka).

DIN 1450:2013.

European Concept for Accessibility. Technical Assistance Manual, ECA 2003.

Hall E.T., *Hidden dimension*, Muza 1997.

ISO 21542:2021. Building construction – Accessibility and usability of the built environment.

ISO 23599:2019. Assistive products for blind and vision-impaired persons – Tactile walking Surface indicators.

Kuryłowicz E., Johnni P., Thuresson C., *Projektowanie uniwersalne: uwarunkowania architektoniczne kształtowania otoczenia wybudowanego przyjaznego dla osób niepełnosprawnych. Sztokholm miasto dla wszystkich: wytyczne tworzenia dostępnego i funkcjonalnego otoczenia zewnętrznego*, Friends of Integration Association 2005.

Nowak E., *Atlas antropometryczny populacji polskiej – dane do projektowania*, Instytut Wzornictwa Przemysłowego, Warsaw 2000.

COMMISSION REGULATION (EU) No 1300/2014 of 18 November 2014 on the technical specifications for interoperability relating to accessibility of the Union's rail system for persons with disabilities and persons with reduced mobility.

Regulation of the Minister of Infrastructure of 3 July 2003 on detailed technical conditions for road signs and signals and road traffic safety devices and the conditions for their placement on roads, *Journal of Laws 2003 No. 220 item 2181.*

Regulation of the Minister of Infrastructure of 12 April 2002 on the technical conditions to be met by buildings and their location, *Journal of Laws. 2015 item 1422.*

Regulation of the Minister of Labour and Social Policy of 26 September 1997 on general regulations of safety and hygiene at work, Journal of Laws 2003 No. 169 item 1650.

Regulation of the Minister of Infrastructure of 24 June 2022 on technical and construction regulations for public roads, Journal of Laws 2022 item 1518.

Schwartz L., Nahlik E., Góral E., *Porady projektowe (vol. 1, 2 and 3)*, KRBRD-MTiGM, 1999-2000.

Act of 21 March 1985 on public roads, Journal of Laws 2016 item 1440.

Building Act of 7 July 1994, Journal of Laws 2017 item 1332.

Act on Road Traffic of 20 June 1997. , Journal of Laws 2017 item 1260.

Table of contents

Introduction	/ 8
INTRODUCTORY INFORMATION	
A. User parameters	/ 16
A.1. Movement and arm reach	/ 16
A.2. Perception	/ 21
A.3. Understanding	/ 26
A.4. Feeling	/ 26
A.5. Culture	/ 27
B. General parameters	/ 29
B.1. Parameters of the circulation space	/ 29
B.2. Level differences	/ 34
B.3. Ramp parameters	/ 35
B.4. Doors	/ 38
B.5. Materials and colour schemes	/ 50
B.6. Electrical installation, access control devices, lighting	/ 54
B.7. Information	/ 57
1. LOCATION OF THE BUILDING AND RELATIONSHIP TO THE SURROUNDINGS	/ 80
1.1. Pedestrian traffic	/ 84
1.2. Designing the traffic system versus people with visual impairments	/ 86
2. CIRCULATION SPACE	/ 92
2.1. Width of circulation spaces	/ 92
2.2. Height of circulation spaces	/ 95
2.3. Overcoming differences in levels	/ 96
2.4. Surfaces	/ 96
2.5. Small architecture	/ 102
2.6. Pedestrian crossings	/ 102
2.7. Cycle routes (paths)	/ 104
3. CAR PARKS AND GARAGES	/ 112
3.1. Location of parking places	/ 112
3.2. Number of parking places for people with disabilities	/ 112
3.3. Parameters of parking places	/ 113
3.4. Parking place marking	/ 114
3.5. Parking vending machines	/ 115
3.6. Management of places for people with disabilities	/ 116

- 4. ENTRANCES / 122
 - 4.1. Location of entrances / 122
 - 4.2. Level differences at the entrance / 122
 - 4.3. Door types and parameters / 123
 - 4.4. Vestibules and manoeuvring spaces at doors / 123
 - 4.5. Partitions and transparent doors / 125
 - 4.6. Footwear cleaning systems / 125
- 5. LOBBY / 132
 - 5.1. Circulation system / 132
 - 5.2. Reception desk / 133
 - 5.3. Cloakroom / 135
 - 5.4. Sitting areas / 136
 - 5.5. Access control gates / 137
- 6. LIFT LOBBIES AND PASSENGER LIFTS / 142
 - 6.1. Size of lift lobbies / 142
 - 6.2. Lift parameters / 142
 - 6.3. Control panels / 145
 - 6.4. Information / 152
 - 6.5. Other vertical transport equipment / 158
- 7. STAIRS – STAIRCASES AND STAIRS IN OPEN SPACES / 174
 - 7.1. Step parameters / 174
 - 7.2. Length of stair flights and landings / 176
 - 7.3. Handrails / 177
 - 7.4. Space under the stairs / 181
 - 7.5. Visual and tactile markings / 183
 - 7.6. Escalators / 185
- 8. OFFICE SPACE / 192
 - 8.1. Circulation space parameters / 192
 - 8.2. Reception areas / 194
 - 8.3. Doors / 194
 - 8.4. Workstations / 194
 - 8.5. Meeting rooms / 197
 - 8.6. Social rooms – kitchens / 199
- 9. DINING AREA / 206
 - 9.1. Circulation space / 206
 - 9.2. Bar and cash register / 207
 - 9.3. Tables / 207

10. HYGIENE AND SANITATION FACILITIES	/ 212
10.1. Location and allocation of toilets	/ 212
10.2. Entrance to the toilet for people with disabilities	/ 214
10.3. Manoeuvring space in the toilet for people with disabilities	/ 216
10.4. Toilet fittings for people with disabilities	/ 219
10.5. Other toilets	/ 226
10.6. Parent-child rooms	/ 228
10.7. Showers	/ 230
10.8. Changing places	/ 232
Bibliography	/ 238

INTE
GRA
CJA

SKANSKA

TAKIE
PANI.

STOWARZYSZENIE ARCHITEKTÓW POLSKICH



BURO HAPPOLD